

Form 8443
September, 1917

PRICE LIST

OF

PARTS



MACHINES
NOS. 6-9 AND 6-10

From the library of: Diamond Needle Corp

THE SINGER MANUFACTURING COMPANY

COPYRIGHT
U. S. A.,
1916 AND 1918
BY
THE SINGER MANUFACTURING CO.
ALL RIGHTS RESERVED FOR ALL COUNTRIES

INDEX

	PAGE
ACCESSORIES.....	18
BELT SHIFTER PARTS.....	17
BOBBIN WINDERS.....	18
DRIVING ATTACHMENT PARTS.....	16
IRON WORK.....	20
MACHINE No. 6-9.....	9
" " 6-10.....	17
NUMERICAL LIST OF PARTS.....	25
OBSOLETE PARTS.....	22

INSTRUCTIONS FOR ORDERING

In ordering from this list, use ONLY the part NUMBER in the FIRST column.

The number stamped on a Sewing Machine part is in every case the number of the single part only.

Every combination of parts sent out as such has its specific number, which, although not stamped on the parts, must be used when ordering the combination.

Each number always indicates the SAME PART in whatever list it appears, or for whatever machine.

The letters after some of the numbers indicate the style of finish only, as follows:

- A. Hardened, Polished and Plated.
- B. Polished and Plated
- C. Hardened only.
- D. Polished only.
- E. Soft, not Polished.
- F. Hardened and Polished.
- G.
- H. Blued.
- J. Plated only.
- K. Hardened and Plated.
- L. Brass or Gilt.
- M. Oxidized.
- P. Japanned.

These letters MUST BE USED when they appear in the list, and AFTER the number as in the list.

In this series

- 1 to 1500 and 50001 to 51500 are Screw Numbers.
- 1501 to 1800 are Nut Numbers.
- 1801 to 2000 are Roller Numbers.
- 2001 to 50000 and 52001 and upward are numbers of Machine Parts.

The figures in the second column refer only to the plates, illustrating the parts, and are NOT TO BE USED in ordering.

Parts marked with an asterisk (*) are furnished only when repairs are made at factory.

LIST OF PARTS COMPLETE FOR MACHINE NO. 6-9

FOR STITCHING BLANK BOOKS, ETC., UP TO 3/4 INCH THICK. MAKES STITCHES FROM 1/4 TO 1 IN. LONG. HAS DROP FEED, VIBRATING PRESSER AND S. D. A

NO.	PLATE	NAME	EACH
*	64019	— Arm	\$35.00
2	8702	7250 " Dowel Pin	15
	9207	7250 " Oil Tube for oiling 9150	10
4	50349E	7274 " Screw	15
4	43263	7270 " " Washer	05
66045	9196	7251 " Shaft	8.50
	9208	7273 " " Bushing	1.00
	434c	7275 " " " Set Screw	04
	9105	7252 " Side Cover	25
	65D	7275 " " " Hinge Screw	12
	8708	7250 " Spool Pin	05
	11241	7263 " " " Washer (cloth) per 100	25
66048	8982	7253 Balance Wheel with two 344c	4.00
	8983	7250 " " Pin	40
2	344c	7276 " " Set Screw	08
	*9223	— Bed	35.00
	11054	7251 Crank Connecting Rod with 9141 and two 575E	1.75
16917	9141	— Crank Connecting Rod Cap	75
	575E	7276 " " " " Screw	05
	369c	7276 " " " " Hinge Screw	20
	1509E	7275 " " " " " Nut	06
	9047	7259 Feed Bar	3.00
2	304c	7276 " " Screw Centre	06
2	15131	7263 " " " " Nut	05
	8994	7255 " Cam with two 432c	1.00
2	432c	7275 " " Set Screw	04
	8927	7255 " Connecting Link	75
	1078c	7276 " " " Hinge Screw for 8930	20
	369c	7276 Feed Connecting Link Hinge Screw for 9058	20
2	1509E	7275 Feed Connecting Link Hinge Screw Nut	06
	9049	7297 " Dog	1.25
	166b	7275 " " Screw	07

NO.	PLATE	NAME	EACH
9058	.7252	Feed Forked Connection	\$2 00
369c	.7276	" " " Hinge Screw	20
1509E	.7275	" " " " " Nut	06
64014	.7251	" Lifting Rock Shaft with 134D, 2022 and 19967	1 75
64015	—	Feed Lifting Rock Shaft complete, Nos. 64014 and 64016	4 25
64016	.7255	Feed Lifting Rock Shaft Crank with 611D, 1619E and 1926	2 50
611D	.7276	Feed Lifting Rock Shaft Crank Clamping Screw	12
1926	.7260	Feed Lifting Rock Shaft Crank Roller with 962c	35
962c	.7276	Feed Lifting Rock Shaft Crank Roller Screw	15
1619E	.7275	Feed Lifting Rock Shaft Crank Roller Screw Nut	05
1015c	.7276	Feed Lifting Rock Shaft Screw Centre (left)	15
1503E	.7275	Feed Lifting Rock Shaft Screw Centre (left) Nut	10
294c	.7276	Feed Lifting Rock Shaft Screw Centre (right)	18
1503E	.7275	Feed Lifting Rock Shaft Screw Centre (right) Nut	10
19967	.7263	Feed Lifting Rock Shaft Wearing Block	35
2022	.7250	" " " " " " " Position Pin	01
134D	.7275	Feed Lifting Rock Shaft Wearing Block Screw	05
8930	.7255	Feed Regulator	75
50527 ^E	17E	.7276 " " Hinge Screw	20
50322D	.7274	" " Thumb Screw	40
9054	.7251	" Rock Shaft	3 25
64017	—	Feed Rock Shaft complete, Nos. 9054 and 9211	4 25
9211	.7255	Feed Rock Shaft Crank with 50124D	1 00
50124D	.7276	" " " " Clamping Screw	12
1015c	.7276	" " " " Screw Centre	15
1503E	.7275	" " " " " Nut	10
26159	.7269	Guide, 10 in. face	60
254D	.7274	" Thumb Screw	40
9145	.7298	Lifting Presser Bar	1 25
9146	.7299	" " " Bell Crank	7 50
9147	—	Lifting Presser Bar Bell Crank complete, Nos. 611c, 9146 and 11025	9 75

9180
9181

NO.	PLATE	NAME	EACH
11025	.7298	Lifting Presser Bar Bell Crank Adjusting Arm with 1513J and 1882	\$2 00
1882	.7300	Lifting Presser Bar Bell Crank Adjusting Arm Roller with 604c	45
604c	.7300	Lifting Presser Bar Bell Crank Adjusting Arm Roller Screw	15
1513J	.7263	Lifting Presser Bar Bell Crank Adjusting Arm Roller Screw Nut	05
611c	.7276	Lifting Presser Bar Bell Crank Adjusting Arm Screw	12
752D	.7300	Lifting Presser Bar Bell Crank Hinge Screw	40
1595E	.7300	Lifting Presser Bar Bell Crank Hinge Screw Nut	08
8715	.7300	Lifting Presser Bar Bell Crank Hinge Screw Nut Washer	25
9214	.7260	Lifting Presser Bar Bushing	75
448c	.7263	" " " " Set Screw	03
9148	.7301	" " " Collar with 453c	15
2022	.7250	" " " " Pin	01
453c	.7263	" " " " Set Screw	02
9108	.7301	" " " Connecting Stud with 523c	2 00
523c	.7276	Lifting Presser Bar Connecting Stud Set Screw	15
11071	.7298	Lifting Presser Bar Guide Bracket with 145D, 193F, 434c and 445c	3 00
145D	.7275	Lifting Presser Bar Guide Bracket Adjusting Screw	04
9110	.7267	Lifting Presser Bar Guide Bracket Guide	1 00
135D	.7275	" " " " " " " Screw	05
434c	.7275	Lifting Presser Bar Guide Bracket Set Screw (long)	04
445c	.7275	Lifting Presser Bar Guide Bracket Set Screw (short)	03
16996	.7267	Lifting Presser Bar Lifter with 8761 and 8763	1 25
8760	.7250	Lifting Presser Bar Lifter Friction Washer	03
16D	.7274	" " " " Hinge Screw	20
8761	.7250	" " " " Stop Pin	05
64020	.7299	" " " Lifting Link	50
64021	.7301	" " " " " Hinge Stud (lower)	40
8973	.7250	Lifting Presser Bar Lifting Link Hinge Stud (lower) Pin	05

From the library of: Diamond Needle Corp

NO.	PLATE	NAME	EACH
43267-8765	7250	Lifting Presser Bar Lifting Link Hinge Stud (lower) Washer	\$ 04
8763	7250	Lifting Presser Bar Lifting Link Hinge Stud (upper)	25
8973	7250	Lifting Presser Bar Lifting Link Hinge Stud (upper) Pin	05
(a) 43267-8765	7250	Lifting Presser Bar Lifting Link Hinge Stud (upper) Washer	04
9021	7273	Lifting Presser Bar Spring (spiral)	25
11031	7252	" " " " (flat)	1 50
58252	7267	" " " " Bracket for 11031	25
2 1177d	7275	Lifting Presser Bar Spring Bracket Screw	04
4389	7250	" " " " Guide Pin for 11031	02
50323d	7274	Lifting Presser Bar Spring Regulating Screw	10
1606e	7275	Lifting Presser Bar Spring Regulating Screw Lock Nut	05
8745	7259	Needle Bar	1 50
2 9214	7260	" " Bushing	75
2 448c	7263	" " " Set Screw	03
8746	7259	" " Connecting Link	1 25
370c	7276	" " " " Hinge Screw	18
1509e	7275	" " " " " " Nut	06
5346-82875	7301	Needle Bar Connecting Stud with two 1149F	3 00
2 1149F	7275	Needle Bar Connecting Stud Clamping Screw	04
9060	7260	Needle Clamp with 149F and 8749	90
8749	7260	" " Gib	25
149F	7260	" " Screw	06
16989	7251	Oil Cup	80
11917	7251	" " Cover	25
9084	7260	" " " Hinge Pin	02
2205	7260	" " " Latch Spring	04
207F	7260	" " " " " Screw	02
41919	7260	" " " Thread Eyelet	05
8953	7260	" or Wax Stripper (felt)	03
11918	7260	" " " " Washer (steel) for 11917	03
8482	7260	Oil or Wax Stripper Washer (steel) for 16989	01
2 207F	7260	Oil or Wax Stripper Washer Screw	02

NO.	PLATE	NAME	EACH
16990	7251	Oil Cup complete, Nos. 2205, 8482, 9084, 11917, 1644919, 16989, two 8953 and three 207F	\$1 25
134d	7275	Oil Cup Screw	05
9150	7259	Oscillating Rock Shaft	7 50
9151	—	Oscillating Rock Shaft complete, Nos. 654c, 9115, 9150, 11165 and two 1503E	9 25
9115	7259	Oscillating Rock Shaft Hinge Pin	1 25
1503e	7275	" " " " " Nut	10
654c	7276	" " " " " Screw Bearing	25
1503e	7275	Oscillating Rock Shaft Hinge Pin Screw Bearing Nut	10
11165	7263	Oscillating Rock Shaft Oil Pad	01
9116	7252	" Shaft	2 00
9152	7263	" " Collar with two 448c	30
2 448c	7263	" " " Set Screw	03
9153	—	" " Crank	2 00
9154	7255	Oscillating Shaft Crank complete, Nos. 445c, 1513j, 9120 and 9153	2 70
9216	7263	Oscillating Shaft Crank Pin	05
445c	7275	" " " Set Screw	03
9119	7263	" " " Slide Block	35
9120	7263	Oscillating Shaft Crank Slide Block complete, Nos. 190d, 1016c, 5968 and 9119	60
190d	7263	Oscillating Shaft Crank Slide Block Cap Screw	03
5968	7263	Oscillating Shaft Crank Slide Block Cap Screw Washer	02
1016c	7263	Oscillating Shaft Crank Slide Block Screw Stud	25
1513j	7263	Oscillating Shaft Crank Slide Block Screw Stud Nut	05
11910	7268	Shuttle Bobbin	25
19977	7268	" Cylinder	1 50
8961	7268	" " Hinge Pin	02
11853	7268	" " Latch	15
12002	7268	" " " Pin	01
19869	7268	" " " Spring	01
19978	7268	" Frame	1 75
773H	7268	" Tension Regulating Screw	05
19979	7268	" " Spring	40
19980	7268	Shuttle (cylinder) 3 in. diam., complete, Nos. 773H, 8961, 11853, 11910, 12002, 19869 and 19977 to 19979, 5821A and 5821B	4 00
8965	7259	Shuttle Driver with 445c	3 00
9216	7263	" " Pin	05

5821A
5821B

DRIVING ATTACHMENT PARTS

NO.	PLATE	NAME	EACH
8982	7253	Balance Wheel with two 344c.....	\$4 00
8983	7250	" " Pin.....	10
344c	7276	" " Set Screw.....	08
8984	7273	Brake Block (wood).....	05
9D	7276	" " Screw.....	20
8985	7253	Friction Pulley with 8986.....	2 75
8986	7273	" " Centre Bearing.....	25
8987	7253	" Washer (paper).....	10
401E	7275	" " Screw.....	02
8988	7253	Lever.....	1 00
9197	7253	" Bracket.....	2 00
497E	7274	" " Bolt with 1522E.....	05
1522E	7275	" " Nut.....	02
134D	7275	" Screw.....	05
8991	7273	" " Washer.....	06
8992	7273	" Spring.....	20
9222	7267	" " Hook.....	15
1520E	7263	" " " Nut.....	03
6055	7263	" " " Washer.....	01
9001	7253	Shaft Driving Pulley, 10 in. diam., 1½ in. face, 1⅜ in. bore (sectional) with two 597c.....	80
597c	7276	Shaft Driving Pulley Clamping Screw.....	08
17603	27636	7253 Treadle.....	30
9082	7250	" Bearing Cotter Pin.....	01
27637	7251	" Pitman Rod (lower).....	05
27638	7260	" " " " Spring.....	03
27639	7251	" " " " (upper).....	05
9079	7251	" " " Clamp with 354c.....	12
354c	7275	" " " " Screw.....	06
27640	7251	Treadle Pitman complete, Nos. 2762, 9079 and 27637 to 27639.....	35
2878	7253	Treadle Stand.....	15
2762	7260	" Stop Collar with 362F.....	10
362F	7275	" " " Set Screw.....	05
126219	27642	7251 Treadle complete, Nos. 2878, 9082, 27636 and four wood screws 1 in. No. 16.....	45
126219	27643	7251 Treadle and Pitman complete, Nos. 27640 and 27642.....	80
64051-9193	—	Driving Attachment complete, Nos. 9D, 134D, 1520E, 6055, 8982 to 8985, 8987, 8988, 8991, 8992, 9091, 9197, 9222, 27613, two 497E and four 401E.....	12 50

MACHINE NO. 6-10

HAS BELT SHIFTER FOR FLAT BELT, OTHERWISE SAME AS MACHINE NO. 6-9

NO.	PLATE	NAME	EACH
9144	7251	Arm Shaft, in place of 9196.....	\$8 50

BELT SHIFTER PARTS

NO.	PLATE	NAME	EACH
61504	7253	Balance Wheel and Pulley (tight) with two 344c, in place of 8982.....	\$6 00
344c	7276	Balance Wheel and Pulley (tight) Set Screw.....	08
6439	—	Chain, length 36 in. to 45 in. NOTE: When ordering No. 6439 give length required.	20
4879	7273	Chain Connecting Link for 4885.....	03
11446	7250	" Eyelet.....	04
9137	7273	" Pulley.....	35
10D	7274	" " Screw.....	25
8805	7253	Fork.....	75
432c	7275	" Set Screw.....	04
8803	7253	Frame with 8804 and two 432c.....	1 75
8804	7253	" Handle.....	30
11451	7253	Guide Rod.....	75
11453	7263	" " Collar with two 448c.....	15
448c	7263	" " " Set Screw.....	03
3012	7250	" " Pin.....	01
11454	7273	" " Spring.....	15
8705	7253	Pulley (loose).....	1 50
9104	7273	" " Collar.....	25
9135	7273	" " Flanged Bushing with two 434c.....	1 00
434c	7275	Pulley (loose) Flanged Bushing Set Screw.....	04
9138	7253	Slide Rod.....	1 50
8873	7250	" " Pin.....	05
4881	7252	Treadle.....	30
4882	7273	" Shaft.....	05
4883	7273	" Spring.....	10
4884	7252	" Stand.....	25
4885	7252	Treadle complete, Nos. 4879, 4881 to 4884 and two wood screws 1 in. No. 16.....	75

From the library of: Diamond Needle Corp

BELT SHIFTER PARTS

NO.	PLATE	NAME	EACH
9139	—	Belt Shifter complete, Nos. 10b, 3012, 4885, 6439, 8705, 8803, 8805, 8873, 9104, 9135, 9137, 9138, 11446, 11451, 11453, 11454 and 61504.	\$13 50

ACCESSORIES

NO.	PLATE	NAME	EACH
11361	7298	Bed Bracket (left) with wood screw 1 in. No. 16.	\$ 10
11360	7298	Bed Bracket (right) with wood screw 1 in. No. 16.	10
	507E, 7275	Bed Bracket Bolt with 1515E.	02
	1515E, 7275	" " " Nut.	02
	36565, 6047	Oiler (copper plated) with 36566.	15
	36566, 6047	" Spout, 9 in. long.	08
	11831, 6047	Screw Driver (large).	20
	26026, 6047	" " (small).	10
	8908, 7284	Wrench for 1654.	08
	8909, 7284	" " 523, 1513 and 50323.	10
	8910, 7284	" " 344, 611, 1509 and 1619.	25
	8911, 7284	" " 1503 and 50124.	15
	9155, 7284	" " 1595.	50
	43184, 7284	" " 1606.	50

BOBBIN WINDERS

BOBBIN WINDER

(SWINGING AUTOMATIC, LEFT HAND)

NO.	PLATE	NAME	EACH
	41894, 6781	Base with 449c.	\$ 50
3	894d, 7275	" Screw.	05
	41895, 7270	Bobbin Carrier Key.	01
	41896, 6782	Frame.	35
	41441, 6782	" Hinge Pin.	10
	449c, 7275	" " " Set Screw.	02
	4784, 7270	" Oil Pad.	01
	41897, 6782	" Spring.	05
4321	43176, 6782	Pulley (leather).	75
4327c	43177, 6782	" Flange with two 448c.	35
(A)	448c, 7263	" " Set Screw.	03
	131d, 7275	" Screw.	04
	43178, 6782	" Washer.	50

(10) 15405.

BOBBIN WINDERS

NO.	PLATE	NAME	EACH
41898, 6781	—	Spindle with 41895.	\$ 25
41557, 6781	—	Stop Latch.	15
41446, 6781	—	" " Hinge Pin.	10
2269, 7250	—	" " Pin.	01
41899, 6782	—	Tripping Arm with 176d.	20
176d, 7275	—	" " Clamping Screw.	03
41900, 6781	—	Bobbin Winder, Nos. 2269, 41441, 41446, 41557, 41894, 41896 to 41899, 43176 to 43178, two 4784 and three 131d.	3 45
41901, 7252	—	Bracket for 41903.	75
41902, 7252	—	" " 41904.	75
523d, 7276	—	" Screw.	15

THREAD UNWINDER PARTS

27555, 7285	—	Spool Pin.	08
27583, 7285	—	" Rest.	20
27556, —	—	" " 27583 with 138B and two 27555.	40
138B, 7275	—	Spool Rest Set Screw.	05
27557, 7285	—	" Stand with 138B.	25
41514, 7285	—	" Weight, 4 in. diam., with 41515.	15
41515, 7250	—	" " Centre Pin.	05
2102, 7270	—	Tension Disc.	05
1560c, 7270	—	" Regulating Thumb Nut.	04
637c, 7270	—	" Screw Stud.	08
2103, 7270	—	" Spring.	03
5769, 7270	—	" Thread Eyelet.	03
41452, 7285	—	Thread Guard.	40
27560, 7285	—	" " Rod, 26 in. long.	30
138B, 7275	—	" " " Set Screw.	05
330D, 7275	—	" " " Set Screw.	02
41453, —	—	Thread Guard complete, Nos. 330D, 637C, 1560C, 2103, 5769, 41452 and two 2102.	70
41823, 7285	—	Thread Unwinder complete, for two large spools, Nos. 27556, 27557, 27560, 41453, two 41514 and three wood screws 1 1/4 in. No. 12.	1 95
41904, —	—	Bobbin Winder (swinging automatic, left hand) complete for 6-9 Machine, Nos. 523D, 41823, 41900, 41902 and three 894D.	6 45
41903, —	—	Bobbin Winder (swinging automatic, left hand) complete for 6-10 Machine, Nos. 523D, 41823, 41900, 41901 and three 894D.	6 45

From the library of: Diamond Needle Corp

BOBBIN WINDER (Hand)FOR MACHINE BED
OBSOLETE

NO.	PLATE	NAME	EACH
11756	—	Belt with 25028.....	\$ 05
25028	7270	" Hook.....	01
11758	6054	Frame.....	50
11759	6054	Pulley.....	25
11760	6054	" Driving Wheel.....	50
8380	6054	" " " Handle (wood)....	03
11762	6054	" " " Stud.....	10
8382	7270	" " " Washer.....	01
11761	—	Pulley Driving Wheel Handle complete, Nos. 8380, 8382 and 11762.....	10
11763	6054	Pulley Driving Wheel Stud.....	10
2269	7250	" " " Pin.....	01
11764	7270	" " " Washer.....	01
11765	6054	Spindle.....	40
11754	7252	Bobbin Winder complete, Nos. 2269, 11756, 11758 to 11761 and 11763 to 11765.....	2 00
135D	7275	Bobbin Winder Screw.....	05

IRON WORK FOR 5292

FOR MACHINE NO. 6-9 WITH S. D. A.

NO.	PLATE	NAME	EACH
41049	—	Belt, size ¼ in., length 91 in., with 25127.	\$ 25
25127	7288	" Hook.....	01
27279	—	Brace (table).....	20
27006	7303	" " 27279 with 499E and two each 12620 and wood screws 1½ in. No. 14.....	30
499E	7288	Brace Bolt with 1522E.....	05
1522E	6793	" " Nut.....	02
12620	6793	" " Washer.....	02
27018	—	Floor Stand complete, Nos. 492E, 12620, 27015, 27022, 27026 and 27028.....	95
27015	6792	Floor Stand or Hanger Foot, 5 in., with six wood screws 1½ in. No. 16.....	25
27022	6792	Journal Box with 27029, 27030 and two 121E.....	35
27026	6792	Journal Box Bracket, 6 in. high, with 421E and 1507J, for 27018.....	25

IRON WORK FOR 5292

21

NO.	PLATE	NAME	EACH
27025	7303	Journal Box Bracket, 6 in. drop, with 421E and 1507J, for 27043.....	\$ 20
27028	6792	Journal Box Bracket Adjusting Slide....	05
492E	6793	" " " Bolt with 1522E, for 27018.....	06
489E	7288	Journal Box Bracket Bolt with 1522E, for 27043.....	08
1522E	6793	Journal Box Bracket Bolt Nut.....	02
12620	6793	" " " " Washer....	02
27029	6793	" " Oil Feeder (felt).....	02
27030	—	" " " Reservoir.....	10
121E	6793	" " Screw.....	06
421E	6793	" " Set Screw.....	08
1507J	6793	" " " Nut.....	05
27038	7303	Leg, 16 in. wide.....	1 05
27042	7303	" 25½ in. wide.....	1 20
27043	—	Leg complete, Nos. 489E, 27022, 27025, 27028, 27042, four 494E and six 12620.....	2 35
494E	7288	Leg Foot Screw.....	05
12620	6793	" " Washer.....	02
27070	7303	Pulley (sectional, grooved) 10 in. diam., 1⅝ in. bore, with two 597c.....	45
597c	6793	Pulley Clamping Screw.....	08
27139	7303	Rail, 16 in. single flat, with two 492E, four 12620 and six wood screws 1½ in. No. 14.....	30
27095	7303	Rail, 30 in. single flat, with two 492E, four each 12620, wood screws 1 in. No. 10 and eight wood screws 1½ in. No. 14....	55
492E	6793	Rail Bolt with 1522E.....	06
1522E	6793	" " Nut.....	02
12620	6793	" " Washer.....	02
27108	6792	Shaft Collar with 432c.....	15
432c	7275	" " Set Screw.....	04
—	—	Seven feet of 1⅝ in. shafting.....	
—	—	Pulley, 10 in. diam., 3 in. face, 1⅝ in. bore	
—	—	Nine feet eight inches of 1 in. flat belting.	
41050	—	Iron Work complete, Nos. 27018, 27038, 27070, 27139, 41049, pulley (solid) 10 in. diam., 3 in. face, 1⅝ in. bore, two each 27043, 27095, 27108, four each 494E, 12620, 27006, seven feet of 1⅝ in. shafting and nine feet eight inches of 1 in. flat belting.....	16 50

From the library of: Diamond Needle Corp

OBSOLETE PARTS

NO.	PLATE	NAME	EACH
*9101	—	Arm.....	\$30 00
496E	7274	" Screw.....	15
9102	7302	" Shaft for 6-10 Machine.....	8 50
9103	7299	" " Bushing.....	1 00
9136	7253	Balance Wheel and Pulley (tight) with two 344c, for 6-10 Machine.....	5 00
*9106	—	Bed.....	30 00
14785	7298	Driving Attachment Lever Spring Hook for 9198.....	10
129E	7275	Crank Connecting Rod Cap Screw for 11054.....	04
9093	7251	Feed Lifting Rock Shaft.....	2 00
9097	—	Feed Lifting Rock Shaft complete, Nos. 9093 and 9096.....	3 10
9096	7255	Feed Lifting Rock Shaft Crank with 1619E, 1926 and two 445c.....	1 10
8873	7250	Feed Lifting Rock Shaft Crank Pin.....	05
445c	7275	" " " " " Set Screw.....	03
254D	7274	" Regulator Thumb Screw.....	40
9053	—	Feed Rock Shaft complete, Nos. 9054 and 9055.....	4 00
9055	7267	Feed Rock Shaft Crank with two 445c.....	75
8873	7250	" " " " Pin.....	05
445c	7275	" " " " " Set Screw.....	03
9107	7298	Lifting Presser Bar Bell Crank with 1882.....	3 50
1882	7300	Lifting Presser Bar Bell Crank Roller with 604c.....	45
604c	7300	Lifting Presser Bar Bell Crank Roller Screw.....	15
11048	7304	Lifting Presser Bar Guide Bracket with 145D, 434c and 445c.....	2 50
9109	—	Lifting Presser Bar Guide Bracket 11048 with 9140.....	2 75
16960	7304	Lifting Presser Bar Lifter with 8761 and 8763.....	1 25
9111	7304	Lifting Presser Bar Lifting Link.....	50
9149	7304	" " " " " ".....	50
9140	7300	" " " " " " Hinge Stud (lower) for 9109.....	40
257E	7275	Lifting Presser Bar Screw Bushing.....	20
8792	7267	" " " Spring (spiral).....	15

NO.	PLATE	NAME	EACH
11032	7304	Lifting Presser Bar Spring Bracket for 11031.....	\$ 25
381D	7275	Lifting Presser Bar Spring Bracket Screw.....	06
609D	7274	" " " " " Regulating Thumb Screw.....	45
9057	7260	Needle Bar Connecting Stud with two 437c.....	2 00
437c	7275	Needle Bar Connecting Stud Set Screw.....	04
257E	7275	" " " Screw Bushing.....	20
11497	7302	Oil Cup.....	80
11921	7302	Oil Cup complete, Nos. 2205, 8482, 9084, 11497, 11917 to 11919, two 8953 and three 207E.....	1 25
9113	7304	Oscillating Rock Shaft.....	7 50
9114	—	Oscillating Rock Shaft complete, Nos. 654c, 9113, 9115, 11165 and two 1503E.....	9 00
9117	—	Oscillating Shaft Crank with 445c.....	1 25
9118	7300	Oscillating Shaft Crank complete, Nos. 1513j, 9117 and 9120.....	1 85
913E	7300	Pressure Regulating Thumb Screw.....	40
11852	833	Shuttle Cylinder for 11851 and 19871.....	1 50
11854	833	" " " " " Latch Spring for 11851.....	03
590E	7275	" " " " " Screw for 11851.....	02
19870	3555	Shuttle Frame with 19869, for 19871.....	1 75
11855	833	" " " for 11851, use 19870.....	1 75
8964	833	" " " Tension Spring for 11851 and 19871.....	40
11851	833	Shuttle (cylinder) 3 in. diam., complete, Nos. 590E, 773H, 8961, 8964, 11852 to 11855, 11910 and 12002, use 19871.....	4 00
19871	3555	Shuttle (cylinder) 3 in. diam., complete, Nos. 773H, 8961, 8964, 11852, 11853, 11910, 12002 and 19870, use 19980.....	4 00
8968	7267	Thread Take-up Lever with 1513j and 1883.....	2 00
8801	7260	Thread Take-up Staple.....	20
9036	7296	Throat Plate for 9049.....	1 00

NUMERICAL LIST OF PARTS

FOR

MACHINES

Nos. 6-9 and 6-10

NUMERICAL LIST OF PARTS

NO.	PLATE	NAME	EACH
9d	7276	Driving Attachment Brake Block Screw for 9198.	\$ 20
10d	7274	Belt Shifter Chain Pulley Screw for 9139.	25
10d	7274	Thread Take-up Lever Hinge Screw.	25
16d	7274	Lifting Presser Bar Lifter Hinge Screw.	20
17E	7276	Feed Regulator Hinge Screw.	20
32d	7275	Shuttle Race Back Spring Screw for 9100.	10
65d	7275	Arm Side Cover Hinge Screw.	02
121E	6793	Journal Box Screw for 27022.	06
123E	7276	Shuttle Race Frame Clamping Screw.	06
129E	7275	Crank Connecting Rod Cap Screw for 11054, obsolete.	04
131d	7275	Bobbin Winder Pulley Screw for 41900.	04
131d	7275	Driving Attachment Lever Screw for 9198.	05
131d	7275	Feed Lifting Rock Shaft Wearing Block Screw for 61014.	05
131d	7275	Oil Cup Screw.	05
134d	7275	Shuttle Race Screw.	05
135d	7275	Bobbin Winder Screw for 11754, obsolete.	05
135d	7275	Lifting Presser Bar Guide Bracket Guide Screw.	05
138B	7275	Bobbin Winder Thread Unwinder Spool Rest Set Screw for 27556.	05
138B	7275	Bobbin Winder Thread Unwinder Thread Guard Rod Set Screw for 27557.	05
145d	7275	Lifting Presser Bar Guide Bracket Adjusting Screw for 11018 and 11071.	01
149E	7260	Needle Clamp Screw for 9060.	06
164d	7275	Thread Take-up Spring Regulator Screw.	01
164d	7275	Vibrating Presser Bar Guide Bracket Cap Screw for 9129.	01
166d	7275	Feed Dog Screw.	07
176d	7275	Bobbin Winder Tripping Arm Clamping Screw for 11899.	03
190d	7263	Oscillating Shaft Crank Slide Block Cap Screw for 9120.	03
193E	7301	Vibrating Presser Bar Hinge Stud Set Screw for 11071.	03
207E	7260	Oil Cup Cover Latch Spring Screw for 11921 and 16990.	02
207E	7260	Oil or Wax Stripper Washer Screw for 11921 and 16990.	02

From the library of Diamond Needle Co.

NUMERICAL LIST OF PARTS

NO.	PLATE	NAME	EACH
225F	7275	Throat Plate Needle Plate Screw for 9125	\$ 03
233D	7301	Vibrating Presser Bar Cushion Screw	02
254D	7274	Feed Regulator Thumb Screw, obsolete	40
254D	7274	Guide Thumb Screw	40
257E	7275	Lifting Presser Bar Screw Bushing, obsolete	20
257E	7275	Needle Bar Screw Bushing, obsolete	20
294C	7276	Feed Lifting Rock Shaft Screw Centre (right)	18
304C	7276	Feed Bar Screw Centre	06
330D	7275	Bobbin Winder Thread Unwinder Thread Guard Set Screw for 41453	02
344C	7276	Balance Wheel and Pulley (tight) Set Screw for 9136 and 61501	08
344C	7276	Balance Wheel Set Screw for 8982	08
354C	7275	Driving Attachment Treadle Pitman Rod Clamp Screw for 9079	06
362F	7275	Driving Attachment Treadle Stop Collar Set Screw for 2762	05
369C	7276	Crank Connecting Rod Hinge Screw	20
369C	7276	Feed Connecting Link Hinge Screw for 9058	20
369C	7276	Feed Forked Connection Hinge Screw	20
370C	7276	Needle Bar Connecting Link Hinge Screw	18
381D	7275	Lifting Presser Bar Spring Bracket Screw, obsolete	06
381D	7275	Throat Plate Screw	06
401E	7275	Driving Attachment Friction Washer Screw for 9198	02
406E	7270	Tension Screw Stud for 8785	25
421E	6793	Journal Box Set Screw for 27025 and 27026	08
432C	7275	Belt Shifter Fork Set Screw for 8803	04
432C	7275	Feed Cam Set Screw for 8994	04
432C	7275	Shaft Collar Set Screw for 27108	04
432C	7275	Thread Take-up Cam Set Screw for 9123	04
434C	7275	Arm Shaft Bushing Set Screw	04
434C	7275	Belt Shifter Pulley (loose) Flanged Bushing Set Screw for 9135	04
434C	7275	Lifting Presser Bar Guide Bracket Set Screw (long) for 11048 and 11071	04
437C	7275	Needle Bar Connecting Stud Set Screw for 9057, obsolete	04
445C	7275	Feed Lifting Rock Shaft Crank Set Screw for 9096, obsolete	03
445C	7275	Feed Rock Shaft Crank Set Screw for 9055, obsolete	03

NUMERICAL LIST OF PARTS

NO.	PLATE	NAME	EACH
445C	7275	Lifting Presser Bar Guide Bracket Set Screw (short) for 11048 and 11071	\$ 03
445C	7275	Oscillating Shaft Crank Set Screw for 9117 and 9154	03
445C	7275	Shuttle Driver Set Screw for 8965	03
448C	7263	Belt Shifter Guide Rod Collar Set Screw for 11453	03
448C	7263	Bobbin Winder Pulley Flange Set Screw for 43177	03
448C	7263	Lifting Presser Bar Bushing Set Screw	03
448C	7263	Needle Bar Bushing Set Screw	03
448C	7263	Oscillating Shaft Collar Set Screw for 9152	03
449C	7275	Bobbin Winder Frame Hinge Pin Set Screw for 41894	02
451C	7300	Vibrating Presser Bar Guide Bracket Set Screw for 9128	03
453C	7263	Lifting Presser Bar Collar Set Screw for 9148	02
489E	7288	Journal Box Bracket Bolt with 1522E, for 27043	08
492E	6793	Journal Box Bracket Bolt with 1522E, for 27018	06
492E	6793	Rail Bolt with 1522E, for 27095 and 27139	06
494E	7288	Leg Foot Screw for 27043 and 41050	05
496E	7274	Arm Screw, obsolete	15
497E	7274	Driving Attachment Lever Bracket Bolt with 1522E, for 9198	05
499E	7288	Brace Bolt with 1522E, for 27006	05
507E	7275	Bed Bracket Bolt with 1515E (Accessories)	02
523D	7276	Bobbin Winder Bracket Screw for 41903 and 41904	15
523C	7276	Lifting Presser Bar Connecting Stud Set Screw for 9108	15
575E	7276	Crank Connecting Rod Cap Screw for 11054	05
590E	7275	Shuttle Cylinder Latch Spring Screw for 11851, obsolete	02
597C	7276	Driving Attachment Shaft Driving Pulley Clamping Screw for 9091	08
597C	6793	Pulley Clamping Screw for 27070	08
604C	7300	Lifting Presser Bar Bell Crank Adjusting Arm Roller Screw for 1882	15
604C	7300	Lifting Presser Bar Bell Crank Roller Screw for 1882, obsolete	15
609D	7274	Lifting Presser Bar Spring Regulating Thumb Screw, obsolete	45

NUMERICAL LIST OF PARTS

NO.	PLATE	NAME	EACH
611D	7276	Feed Lifting Rock Shaft Crank Clamping Screw for 64016.....	\$ 12
611c	7276	Lifting Presser Bar Bell Crank Adjusting Arm Screw for 9147.....	12
637c	7270	Bobbin Winder Thread Unwinder Tension Screw Stud for 41453.....	08
654c	7276	Oscillating Rock Shaft Hinge Pin Screw Bearing for 9114 and 9151.....	25
690D	7275	Thread Take-up Staple Screw.....	05
690D	7275	Vibrating Presser Foot Screw.....	05
752D	7300	Lifting Presser Bar Bell Crank Hinge Screw.....	40
773H	7268	Shuttle Tension Regulating Screw for 11851, 19871 and 19980.....	05
894D	7275	Bobbin Winder Base Screw for 41903 and 41904.....	05
913E	7300	Pressure Regulating Thumb Screw, obsolete.....	40
962c	7276	Feed Lifting Rock Shaft Crank Roller Screw for 1926.....	15
1015c	7276	Feed Lifting Rock Shaft Screw Centre (left).....	15
1015c	7276	Feed Rock Shaft Screw Centre.....	15
1016c	7263	Oscillating Shaft Crank Slide Block Screw Stud for 9120.....	25
1078c	7276	Feed Connecting Link Hinge Screw for 8930.....	20
1149F	7275	Needle Bar Connecting Stud Clamping Screw for 32875.....	04
1177D	7275	Lifting Presser Bar Spring Bracket Screw.....	04
1503E	7275	Feed Lifting Rock Shaft Screw Centre (left) Nut.....	10
1503E	7275	Feed Lifting Rock Shaft Screw Centre (right) Nut.....	10
1503E	7275	Feed Rock Shaft Screw Centre Nut.....	10
1503E	7275	Oscillating Rock Shaft Hinge Pin Nut for 9114 and 9151.....	10
1503E	7275	Oscillating Rock Shaft Hinge Pin Screw Bearing Nut for 9114 and 9151.....	10
1507J	6793	Journal Box Set Screw Nut for 27025 and 27026.....	05
1509E	7275	Crank Connecting Rod Hinge Screw Nut.....	06
1509E	7275	Feed Connecting Link Hinge Screw Nut.....	06
1509E	7275	" Forked Connection Hinge Screw Nut.....	06
1509E	7275	Needle Bar Connecting Link Hinge Screw Nut.....	06
1513J	7263	Feed Bar Screw Centre Nut.....	05

NUMERICAL LIST OF PARTS

NO.	PLATE	NAME	EACH
1513J	7263	Lifting Presser Bar Bell Crank Adjusting Arm Roller Screw Nut for 11025.....	\$ 05
1513J	7263	Oscillating Shaft Crank Slide Block Screw Stud Nut for 9118 and 9154.....	05
1513J	7263	Thread Take-up Lever Roller and Screw Stud Nut for 8968 and 9218.....	05
1515E	7275	Bed Bracket Bolt Nut for 507.....	02
1520E	7263	Driving Attachment Lever Spring Hook Nut for 9198.....	03
1522E	6793	Brace Bolt Nut for 499.....	02
1522E	7275	Driving Attachment Lever Bracket Bolt Nut for 497.....	02
1522E	6793	Journal Box Bracket Bolt Nut for 489 and 492.....	02
1522E	6793	Rail Bolt Nut for 492.....	02
1535E	7270	Tension Regulating Thumb Nut for 8785.....	10
1560c	7270	Bobbin Winder Thread Unwinder Tension Regulating Thumb Nut for 41453.....	01
1595E	7300	Lifting Presser Bar Bell Crank Hinge Screw Nut.....	08
1606E	7275	Lifting Presser Bar Spring Regulating Screw Lock Nut.....	05
1619E	7275	Feed Lifting Rock Shaft Crank Roller Screw Nut for 9096 and 64016.....	05
1654c	7301	Vibrating Presser Foot Screw Nut.....	04
1882	7300	Lifting Presser Bar Bell Crank Adjusting Arm Roller with 604c, for 11025.....	45
1882	7300	Lifting Presser Bar Bell Crank Roller with 604c, for 9107, obsolete.....	45
1883	7275	Thread Take-up Lever Roller and Screw Stud for 8968 and 9218.....	35
1926	7260	Feed Lifting Rock Shaft Crank Roller with 962c, for 9096 and 64016.....	35
2022	7250	Feed Lifting Rock Shaft Wearing Block Position Pin for 64014.....	01
2022	7250	Lifting Presser Bar Collar Pin.....	01
2102	7270	Bobbin Winder Thread Unwinder Tension Disc for 41453.....	05
2103	7270	Bobbin Winder Thread Unwinder Tension Spring for 41453.....	03
2117	7250	Vibrating Presser Bar Guide Bracket Pin.....	01
2205	7260	Oil Cup Cover Latch Spring for 11921 and 16990.....	04
2269	7250	Bobbin Winder Pulley Driving Wheel Stud Pin for 11754, obsolete.....	01
2269	7250	Bobbin Winder Stop Latch Pin for 41900.....	01

NUMERICAL LIST OF PARTS

NO.	PLATE	NAME	EACH
2762	7260	Driving Attachment Treadle Stop Collar with 362E, for 27640.....	\$ 10
2878	7253	Driving Attachment Treadle Stand 27642.....	15
3012	7250	Belt Shifter Guide Rod Pin for 9139.....	01
4389	7250	Lifting Presser Bar Spring Guide Pin for 11031.....	02
4784	7270	Bobbin Winder Frame Oil Pad for 41900.....	01
4879	7273	Belt Shifter Chain Connecting Link for 4885.....	03
		Nos. 4881 to 4884 for 4885.....	
4881	7252	Belt Shifter Treadle.....	30
4882	7273	" " " Shaft.....	05
4883	7273	" " " Spring.....	10
4884	7252	" " " Stand.....	25
4885	7252	Belt Shifter Treadle complete for 9139, Nos. 4879, 4881 to 4884 and two wood screws 1 in. No. 16.....	75
5769	7270	Bobbin Winder Thread Unwinder Tension Thread Eyelet for 41453.....	03
5968	7263	Oscillating Shaft Crank Slide Block Cap Screw Washer for 9120.....	02
6055	7263	Driving Attachment Lever Spring Hook Nut Washer for 9198.....	01
6439	—	Belt Shifter Chain, length 36 in. to 45 in., for 9139.....	20
8380	6054	Bobbin Winder Pulley Driving Wheel Handle (wood) for 11761, obsolete....	03
8382	7270	Bobbin Winder Pulley Driving Wheel Handle Stud Washer for 11761, obsolete	01
8482	7260	Oil or Wax Stripper Washer (steel) for 11497 for 11921 and for 16989 for 16990	01
8702	7250	Arm Dowel Pin.....	15
8705	7253	Belt Shifter Pulley (loose) for 9139.....	1 50
8708	7250	Arm Spool Pin.....	05
8714	7250	Thread Take-up Cam Pin.....	15
8715	7300	Lifting Presser Bar Bell Crank Hinge Screw Nut Washer.....	25
8734	7270	Vibrating Presser Bar Spring.....	08
8745	7259	Needle Bar.....	1 50
8746	7259	" " Connecting Link.....	1 25
8749	7260	" Clamp Gib for 9060.....	25
8760	7250	Lifting Presser Bar Lifter Friction Washer	03
8761	7250	" " " " Stop Pin for 16960 and 16996.....	05
8763	7250	Lifting Presser Bar Lifting Link Hinge Stud (upper) for 16960 and 16996.....	25

NUMERICAL LIST OF PARTS

NO.	PLATE	NAME	EACH
8765	7250	Lifting Presser Bar Lifting Link Hinge Stud (lower) Washer.....	\$ 04
8765	7250	Lifting Presser Bar Lifting Link Hinge Stud (upper) Washer.....	04
8785	—	Tension complete, Nos. 406E, 1535E, 8787, 8788 and two 8786.....	90
		Nos. 8786 to 8788 for 8785.....	
8786	7270	Tension Disc.....	15
8787	7270	" Regulating Thumb Nut Washer.....	01
8788	7270	" Spring.....	25
8792	7267	Lifting Presser Bar Spring (spiral) obsolete	15
8799	7260	Thread Take-up Spring Regulator.....	15
8801	7260	" " Staple, obsolete.....	20
8803	7253	Belt Shifter Frame with 8804 and two 432c, for 9139.....	1 75
8804	7253	Belt Shifter Frame Handle for 8803.....	30
8805	7253	" " Fork for 9139.....	75
8873	7250	" " Slide Rod Pin for 9139.....	05
8873	7250	Feed Lifting Rock Shaft Crank Pin, obsolete.....	05
8873	7250	Feed Rock Shaft Crank Pin, obsolete....	05
8908	7284	Wrench for 1654 (Accessories).....	08
8909	7284	" " 523, 1513 and 50323 (Accessories).....	10
8910	7284	Wrench for 344, 611, 1509 and 1619 (Accessories).....	25
8911	7284	Wrench for 1503 and 50124 (Accessories)	15
8927	7255	Feed Connecting Link.....	75
8930	7255	" Regulator.....	75
8953	7260	Oil or Wax Stripper (felt) for 11921 and 16990.....	03
8961	7268	Shuttle Cylinder Hinge Pin for 11851, 19871 and 19980.....	02
8964	833	Shuttle Tension Spring for 11851 and 19871, obsolete.....	40
8965	7259	Shuttle Driver with 445c.....	3 00
8968	7267	Thread Take-up Lever with 1513r and 1883, obsolete.....	2 00
8973	7250	Lifting Presser Bar Lifting Link Hinge Stud (lower) Pin.....	05
8973	7250	Lifting Presser Bar Lifting Link Hinge Stud (upper) Pin.....	05
8982	7253	Balance Wheel with two 344c, for 6-9 Machine.....	4 00
8983	7250	Balance Wheel Pin for 6-9 Machine.....	10

NO.	PLATE	NAME	EACH
8984	7273	Driving Attachment Brake Block (wood) for 9198.....	\$ 05
8985	7253	Driving Attachment Friction Pulley with 8986, for 9198.....	2 75
8986	7273	Driving Attachment Friction Pulley Centre Bearing for 8985.....	25
8987	7253	Driving Attachment Friction Washer (paper) for 9198.....	10
8988	7253	Driving Attachment Lever for 9198.....	1 00
8991	7273	" " " Screw Washer for 9198.....	06
8992	7273	Driving Attachment Lever Spring for 9198.....	20
8994	7255	Feed Cam with two 432c.....	1 00
9021	7273	Lifting Presser Bar Spring (spiral).....	25
9036	7296	Throat Plate for 9049, obsolete.....	1 00
9047	7259	Feed Bar.....	3 00
9049	7297	" Dog.....	1 25
9053	—	Feed Rock Shaft complete, Nos. 9051 and 9055, obsolete.....	4 00
9054	7251	Feed Rock Shaft for 9053 and 64017.....	3 25
9055	7267	" " " Crank with two 445c, for 9053, obsolete.....	75
9057	7260	Needle Bar Connecting Stud with two 437c, obsolete.....	2 00
9058	7252	Feed Forked Connection.....	2 00
9060	7260	Needle Clamp with 149r and 8749.....	90
9079	7251	Driving Attachment Treadle Pitman Rod Clamp with 354c, for 27640.....	12
9082	7250	Driving Attachment Treadle Bearing Cotter Pin for 27642.....	01
9084	7260	Oil Cup Cover Hinge Pin for 11921 and 16990.....	02
9089	7301	Vibrating Presser Foot.....	2 50
9091	7253	Driving Attachment Shaft Driving Pulley, 10 in. diam., 1½ in. face, 1¾ in. bore (sectional) with two 597c, for 9198.....	80
9093	7251	Feed Lifting Rock Shaft for 9097, obsolete.....	2 00
9096	7255	Feed Lifting Rock Shaft Crank with 1619e, 1926 and two 445c, for 9097, obsolete.....	1 10
9097	—	Feed Lifting Rock Shaft complete, Nos. 9093 and 9096, obsolete.....	3 10
9098	7252	Shuttle Race Body for 9100.....	2 75
9099	7252	" " Frame with 11838.....	2 00
9100	—	Shuttle Race (flexible back) complete, Nos. 32b, 9098, 11832, 11834 and two 11833.....	4 00

NO.	PLATE	NAME	EACH
*9101	—	Arm, obsolete.....	\$30 00
9102	7302	" Shaft for 6-10 Machine, obsolete....	8 50
9103	7299	" " Bushing, obsolete.....	1 00
9104	7273	Belt Shifter Pulley (loose) Collar for 9139.....	25
9105	7252	Arm Side Cover.....	25
*9106	—	Bed, obsolete.....	30 00
9107	7298	Lifting Presser Bar Bell Crank with 1882, obsolete.....	3 50
9108	7301	Lifting Presser Bar Connecting Stud with 523c.....	2 00
9109	—	Lifting Presser Bar Guide Bracket 11048 with 9140, obsolete.....	2 75
9110	7267	Lifting Presser Bar Guide Bracket Guide.....	1 00
9111	7304	" " " Lifting Link, obsolete.....	50
9112	—	No. cancelled, order 9060.....	
9113	7304	Oscillating Rock Shaft for 9114, obsolete.....	7 50
9114	—	Oscillating Rock Shaft complete, Nos. 654c, 9113, 9115, 11165 and two 1503E, obsolete.....	9 00
9115	7259	Oscillating Rock Shaft Hinge Pin for 9114 and 9151.....	1 25
9116	7252	Oscillating Shaft.....	2 00
9117	—	" " Crank with 445c, for 9118, obsolete.....	1 25
9118	7300	Oscillating Shaft Crank complete, Nos. 1513r, 9117 and 9120, obsolete.....	1 85
9119	7263	Oscillating Shaft Crank Slide Block for 9120.....	35
9120	7263	Oscillating Shaft Crank Slide Block complete for 9118 and 9151, Nos. 190b, 1016c, 5968 and 9119.....	60
9121	7269	Shuttle Race Slide (right).....	35
9122	7269	" " " (left).....	50
9123	7302	Thread Take-up Cam with 432c.....	8 50
9124	7263	" " Spring.....	15
9125	7297	Throat Plate with 225r and 9126, for 9049.....	1 75
9126	7297	" " Needle Plate for 9125.....	50
9127	7299	Vibrating Presser Bar with 9131 and two 9291.....	2 00
9128	7299	Vibrating Presser Bar Guide Bracket with 451c, for 9129.....	1 25
9129	—	Vibrating Presser Bar Guide Bracket complete, Nos. 9128, 9130 and two 164b....	1 50
9130	7299	Vibrating Presser Bar Guide Bracket Cap with 19614, for 9129.....	20
9131	7299	Vibrating Presser Bar Spring Bracket with 19614, for 9127.....	50

From the Catalog of the Mod. Needle Co.

NUMERICAL LIST OF PARTS

NO.	PLATE	NAME	EACH
9135	7273	Belt Shifter Pulley (loose) Flanged Bushing with two 434c, for 9139.....	\$1 00
9136	7253	Balance Wheel and Pulley (tight) with two 344c, for 6-10 Machine, obsolete.....	5 00
9137	7273	Belt Shifter Chain Pulley for 9139.....	35
9138	7253	" " Slide Rod for 9139.....	1 50
9139	—	Belt Shifter complete for 6-10 Machine, Nos. 10d, 3012, 4885, 6439, 8705, 8803, 8805, 8873, 9104, 9135, 9137, 9138, 11446, 11451, 11453, 11454 and 61504.....	13 50
9140	7300	Lifting Presser Bar Lifting Link Hinge Stud (lower) for 9109, obsolete.....	40
*9141	—	Crank Connecting Rod Cap for 11054.....	75
9144	7251	Arm Shaft for 6-10 Machine.....	8 50
9145	7298	Lifting Presser Bar.....	1 25
9146	7299	" " " Bell Crank for 9147.....	7 50
9147	—	Lifting Presser Bar Bell Crank complete, Nos. 611c, 9146 and 11025.....	9 75
9148	7301	Lifting Presser Bar Collar with 453c.....	15
9149	7304	" " " Lifting Link, obsolete.....	50
9150	7259	Oscillating Rock Shaft for 9151.....	7 50
9151	—	Oscillating Rock Shaft complete, Nos. 654c, 9115, 9150, 11165 and two 1503E.....	9 25
9152	7263	Oscillating Shaft Collar with two 448c.....	30
9153	—	" " " Crank for 9154.....	2 00
9154	7255	Oscillating Shaft Crank complete, Nos. 445c, 1513r, 9120 and 9153.....	2 70
9155	7284	Wrench for 1595 (Accessories).....	50
9186	7301	Thread Take-up Staple.....	20
9196	7251	Arm Shaft for 6-9 Machine.....	8 50
9197	7253	Driving Attachment Lever Bracket for 9198.....	2 00
9198	—	Driving Attachment complete for 6-9 Machine, Nos. 9d, 134d, 1520E, 6055, 8982 to 8985, 8987, 8988, 8991, 8992, 9091, 9197, 9222, 27643, two 497E and four 401E.....	12 50
9207	7250	Arm Oil Tube for oiling 9150.....	10
9208	7273	" Shaft Bushing.....	1 00
9211	7255	Feed Rock Shaft Crank with 50124d, for 64017.....	1 00
9214	7260	Lifting Presser Bar Bushing.....	75
9214	7260	Needle Bar Bushing.....	75
9216	7263	Oscillating Shaft Crank Pin.....	05
9216	7263	Shuttle Driver Pin.....	05
9218	7259	Thread Take-up Lever with 1513r, 1883 and 9219.....	2 25

NUMERICAL LIST OF PARTS

NO.	PLATE	NAME	EACH
9219	7250	Thread Take-up Lever Thread Eyelet Bushing for 9218.....	\$ 25
9222	7267	Driving Attachment Lever Spring Hook for 9198.....	15
*9223	—	Bed.....	35 00
9291	7250	Vibrating Presser Bar Spring Bracket Rivet for 9127.....	01
11025	7298	Lifting Presser Bar Bell Crank Adjusting Arm with 1513r and 1882, for 9147.....	2 00
11031	7252	Lifting Presser Bar Spring (flat).....	1 50
11032	7304	" " " " Bracket for 11031, obsolete.....	25
11048	7304	Lifting Presser Bar Guide Bracket with 145b, 434c and 445c, for 9109, obsolete.....	2 50
11054	7251	Crank Connecting Rod with 9141 and two 575E.....	1 75
11071	7298	Lifting Presser Bar Guide Bracket with 145b, 193E, 434c and 445c.....	3 00
11072	7301	Vibrating Presser Bar Hinge Stud.....	25
11165	7263	Oscillating Rock Shaft Oil Pad for 9114 and 9151.....	05
11241	7263	Arm Spool Pin Washer (cloth)..... per 100	25
11360	7298	Bed Bracket (right) with wood screw 1 in. No. 16 (Accessories).....	10
11361	7298	Bed Bracket (left) with wood screw 1 in. No. 16 (Accessories).....	10
11446	7250	Belt Shifter Chain Eyelet for 9139.....	05
11451	7253	" " " Guide Rod for 9139.....	75
11453	7263	" " " " Collar with two 448c, for 9139.....	15
11454	7273	Belt Shifter Guide Rod Spring for 9139.....	15
11497	7302	Oil Cup for 11921, obsolete.....	80
11509	7301	Vibrating Presser Bar Cushion (rawhide).....	01
11754	7252	Bobbin Winder (hand, for machine bed) complete, Nos. 2269, 11756, 11758 to 11761 and 11763 to 11765, obsolete.....	2 00
11756	—	Bobbin Winder Belt with 25028, for 11754, obsolete.....	05
Nos. 11758 to 11761 FOR 11754, OBSOLETE.			
11758	6054	Bobbin Winder Frame.....	50
11759	6054	" " Pulley.....	25
11760	6054	" " " Driving Wheel.....	50
11761	—	Bobbin Winder Pulley Driving Wheel Handle complete, Nos. 8380, 8382 and 11762.....	10

NUMERICAL LIST OF PARTS

NO.	PLATE	NAME	EACH
11762	6054	Bobbin Winder Pulley Driving Wheel Handle Stud for 11761, obsolete.....	\$ 10
Nos. 11763 to 11765 FOR 11751, OBSOLETE.			
11763	6054	Bobbin Winder Pulley Driving Wheel Stud.....	10
11764	7270	Bobbin Winder Pulley Driving Wheel Stud Washer.....	01
11765	6054	Bobbin Winder Spindle.....	40
11831	6047	Screw Driver, large (Accessories).....	20
Nos. 11832 to 11834 FOR 9100.			
11832	7255	Shuttle Race Back.....	1 00
11833	7250	“ “ “ Position Pin.....	01
11834	7255	“ “ “ Spring.....	25
11838	7250	“ “ “ Frame Position Pin for 9099	03
11851	833	Shuttle (cylinder) 3 in. diam., complete, Nos. 590E, 773H, 8961, 8964, 11852 to 11855, 11910 and 12002, obsolete, use 19871.....	4 00
11852	833	Shuttle Cylinder for 11851 and 19871, obsolete.....	1 50
11853	7268	Shuttle Cylinder Latch for 11851, 19871 and 19980.....	15
11854	833	Shuttle Cylinder Latch Spring for 11851, obsolete.....	03
11855	833	Shuttle Frame for 11851, obsolete, use 19870.....	1 75
11910	7268	Shuttle Bobbin for 11851, 19871 and 19980.....	25
Nos. 11917 to 11919 FOR 11921 AND 16990.			
11917	7251	Oil Cup Cover.....	25
11918	7260	“ or Wax Stripper Washer (steel) for 11917.....	03
11919	7260	Oil Cup Thread Eyelet.....	05
11921	7302	Oil Cup complete, Nos. 2205, 8482, 9084, 11497, 11917 to 11919, two 8953 and three 207E, obsolete.....	1 25
11950	7301	Thread Eyelet (side of arm).....	05
12002	7268	Shuttle Cylinder Latch Pin for 11851, 19871 and 19980.....	01
12620	6793	Brace Bolt Nut Washer for 27006.....	02
12620	6793	Journal Box Bracket Bolt Nut Washer for 27018 and 27043.....	02
12620	6793	Leg Foot Screw Washer for 27043 and 41050.....	02

NUMERICAL LIST OF PARTS

NO.	PLATE	NAME	EACH
12620	6793	Rail Bolt Nut Washer for 27095 and 27139	\$ 02
14785	7298	Driving Attachment Lever Spring Hook for 9198, obsolete.....	10
16960	7304	Lifting Presser Bar Lifter with 8761 and 8763, obsolete.....	1 25
16989	7251	Oil Cup for 16990.....	80
16990	7251	Oil Cup complete, Nos. 2205, 8482, 9084, 11917 to 11919, 16989, two 8953 and three 207E.....	1 25
16996	7267	Lifting Presser Bar Lifter with 8761 and 8763.....	1 25
19614	7250	Vibrating Presser Bar Spring Hook for 9130 and 9131.....	05
19869	7268	Shuttle Cylinder Latch Spring for 19870 and 19980.....	01
19870	3555	Shuttle Frame with 19869, for 19871, obsolete.....	1 75
19871	3555	Shuttle (cylinder) 3 in. diam., complete, Nos. 773H, 8961, 8964, 11852, 11853, 11910, 12002 and 19870, obsolete, use 19980.....	4 00
19967	7263	Feed Lifting Rock Shaft Wearing Block for 64014.....	35
Nos. 19977 TO 19979 FOR 19980.			
19977	7268	Shuttle Cylinder.....	1 50
19978	7268	“ Frame.....	1 75
19979	7268	“ Tension Spring.....	40
19980	7268	Shuttle (cylinder) 3 in. diam., complete, Nos. 773H, 8961, 11853, 11910, 12002, 19869 and 19977 to 19979.....	4 00
25028	7270	Bobbin Winder Belt Hook for 11756, obsolete.....	01
25127	7288	Belt Hook for 41049.....	01
26026	6047	Screw Driver, small (Accessories).....	10
26159	7269	Guide, 10 in. face.....	60
27006	7303	Brace (table) 27279 with 499E and two each 12620 and wood screws 1½ in. No. 14, for 41050.....	30
27015	6792	Floor Stand or Hanger Foot, 5 in., with six wood screws 1½ in. No. 16, for 27018	25
27018	—	Floor Stand complete for 41050, Nos. 492E, 12620, 27015, 27022, 27026 and 27028.....	95
27022	6792	Journal Box with 27029, 27030 and two 121E, for 27018 and 27043.....	35

NO.	PLATE	NAME	EACH
27025	7303	Journal Box Bracket, 6 in. drop, with 421E and 1507J, for 27043.....	\$ 20
27026	6792	Journal Box Bracket, 6 in. high, with 421E and 1507J, for 27018.....	25
27028	6792	Journal Box Bracket Adjusting Slide for 27018 and 27043.....	05
27029	6793	Journal Box Oil Feeder (felt) for 27022..	02
27030	—	“ “ “ “ Reservoir for 27022.....	10
27038	7303	Leg, 16 in. wide, for 41050.....	1 05
27042	7303	“ 25½ in. wide, for 27043.....	1 20
27043	—	Leg complete for 41050, Nos. 489E, 27022, 27025, 27028, 27042, four 494E and six 12620.....	2 35
27070	7303	Pulley (sectional, grooved) 10 in. diam., 1⅜ in. bore, with two 597C, for 41050..	45
27095	7303	Rail, 30 in. single flat, with two 492E, four each 12620, wood screws 1 in. No. 10 and eight wood screws 1½ in. No. 14, for 41050.....	55
27108	6792	Shaft Collar with 432C, for 41050.....	15
27139	7303	Rail, 16 in. single flat, with two 492E, four 12620 and six wood screws 1½ in. No. 14, for 41050.....	30
27279	—	Brace (table) for 27006.....	20
27555	7285	Bobbin Winder Thread Unwinder Spool Pin for 27556.....	08
27556	—	Bobbin Winder Thread Unwinder Spool Rest 27583 with 138B and two 27555, for 41823.....	40
27557	7285	Bobbin Winder Thread Unwinder Spool Stand with 138B, for 41823.....	25
27560	7285	Bobbin Winder Thread Unwinder Thread Guard Rod, 26 in. long, for 41823.....	30
27583	7285	Bobbin Winder Thread Unwinder Spool Rest for 27556.....	20
27636	7253	Driving Attachment Treadle for 27642.. Nos. 27637 to 27639 for 27640.	30
27637	7251	Driving Attachment Treadle Pitman Rod (lower).....	05
27638	7260	Driving Attachment Treadle Pitman Rod (lower) Spring.....	03
27639	7251	Driving Attachment Treadle Pitman Rod (upper).....	05

NO.	PLATE	NAME	EACH
27640	7251	Driving Attachment Treadle Pitman complete for 27643, Nos. 2762, 9079 and 27637 to 27639.....	\$ 35
27642	—	Driving Attachment Treadle complete for 27643, Nos. 2878, 9082, 27636 and four wood screws 1 in. No. 16.....	45
27643	—	Driving Attachment Treadle and Pitman complete for 9198, Nos. 27640 and 27642	80
32875	7301	Needle Bar Connecting Stud with two 1149F.....	3 00
36565	6017	Oiler (copper plated) with 36566 (Accessories).....	15
36566	6017	Oiler Spout, 9 in. long, for 36565.....	08
41049	—	Belt, size ¼ in., length 91 in., with 25127, for 41050.....	25
41050	—	Iron Work complete for 5292 for 6-9 Machine with S. D. A., Nos. 27018, 27038, 27070, 27139, 41049, pulley (solid) 10 in. diam., 3 in. face, 1⅜ in. bore, two each 27043, 27095, 27108, four each 494E, 12620, 27006, seven feet of 1⅜ in. shafting and nine feet eight inches of 1 in. flat belting.....	16 50
41441	6782	Bobbin Winder Frame Hinge Pin for 41900.....	10
41446	6781	Bobbin Winder Stop Latch Hinge Pin for 41900.....	10
41452	7285	Bobbin Winder Thread Unwinder Thread Guard for 41453.....	40
41453	—	Bobbin Winder Thread Unwinder Thread Guard complete for 41823, Nos. 330B, 637C, 1560C, 2103, 5769, 41452 and two 2102.....	70
41514	7285	Bobbin Winder Thread Unwinder Spool Weight, 4 in. diam., with 41515, for 41823.....	15
41515	7250	Bobbin Winder Thread Unwinder Spool Weight Centre Pin for 41514.....	05
41544	7250	Thread Take-up Spring Regulator Screw Washer.....	05
41544	7250	Thread Take-up Staple Screw Washer...	05
41557	6781	Bobbin Winder Stop Latch for 41900....	15
41823	7285	Bobbin Winder Thread Unwinder complete, for two large spools, for 41903 and 41904, Nos. 27556, 27557, 27560, 41453, two 41514 and three wood screws 1¼ in. No. 12.....	1 95

From the library of Diamond Needle Co.

NUMERICAL LIST OF PARTS

NO.	PLATE	NAME	EACH
41894	6781	Bobbin Winder Base with 419c, for 41900	\$ 50
41895	7270	" " Bobbin Carrier Key for 41898.....	01
Nos. 41896 TO 41899 FOR 41900.			
41896	6782	Bobbin Winder Frame.....	35
41897	6782	" " " Spring.....	05
41898	6781	" " Spindle with 41895.....	25
41899	6782	" " Tripping Arm with 176d..	20
41900	6781	" " for 41903 and 41904, Nos. 2269, 41441, 41446, 41557, 41894, 41896 to 41899, 43176 to 43178, two 4784 and three 131d.....	3 45
41901	7252	Bobbin Winder Bracket for 41903.....	75
41902	7252	" " " " 41904.....	75
41903	—	Bobbin Winder (swinging automatic, left hand) complete for 6-10 Machine, Nos. 523d, 41823, 41900, 41901 and three 894d.....	6 45
41904	—	Bobbin Winder (swinging automatic, left hand) complete for 6-9 Machine, Nos. 523d, 41823, 41900, 41902 and three 894d.....	6 45
Nos. 43176 TO 43178 FOR 41900.			
43176	6782	Bobbin Winder Pulley (leather).....	75
43177	6782	" " " Flange with two 448c.....	35
43178	6782	Bobbin Winder Pulley Washer.....	50
43184	7284	Wrench for 1606 (Accessories).....	50
43263	7270	Arm Screw Washer.....	05
50124d	7276	Feed Rock Shaft Crank Clamping Screw for 9211.....	12
50322d	7274	Feed Regulator Thumb Screw.....	40
50323d	7274	Lifting Presser Bar Spring Regulating Screw.....	10
50349E	7274	Arm Screw.....	15
58252	7267	Lifting Presser Bar Spring Bracket for 11031.....	25
61504	7253	Balance Wheel and Pulley (tight) with two 344c, for 6-10 Machine.....	6 00
64014	7251	Feed Lifting Rock Shaft with 134d, 2022 and 19967, for 64015.....	1 75
64015	—	Feed Lifting Rock Shaft complete, Nos. 64014 and 64016.....	4 25
64016	7255	Feed Lifting Rock Shaft Crank with 611d, 1619E and 1926, for 64015.....	2 50

NUMERICAL LIST OF PARTS

NO.	PLATE	NAME	EACH
64017	—	Feed Rock Shaft complete, Nos. 9054 and 9211.....	\$ 1 25
*64019	—	Arm.....	35 00
64029	7299	Lifting Presser Bar Lifting Link.....	50
64021	7301	" " " " Hinge Stud (lower).....	40

**ILLUSTRATIONS OF PARTS
FOR
MACHINES
Nos. 6-9 and 6-10**

From the library of Diamond Needle Corp

PLATE 833—FULL SIZE

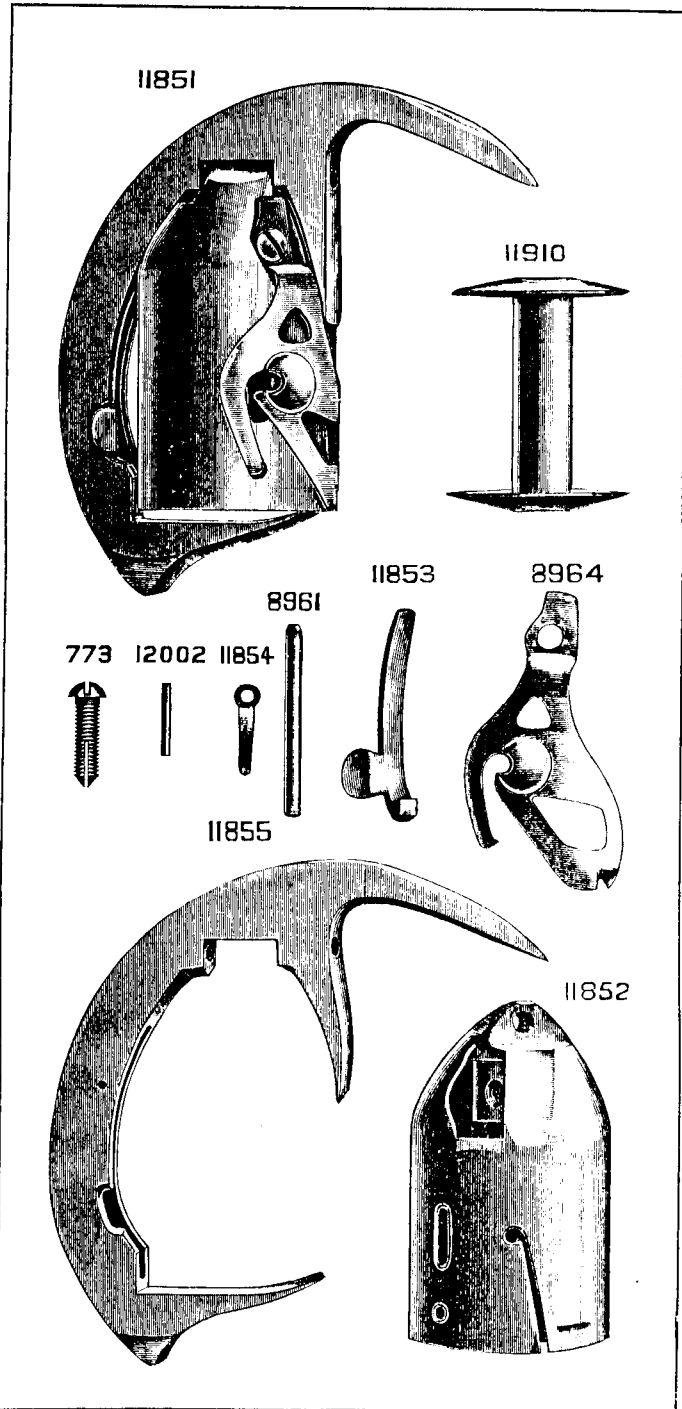
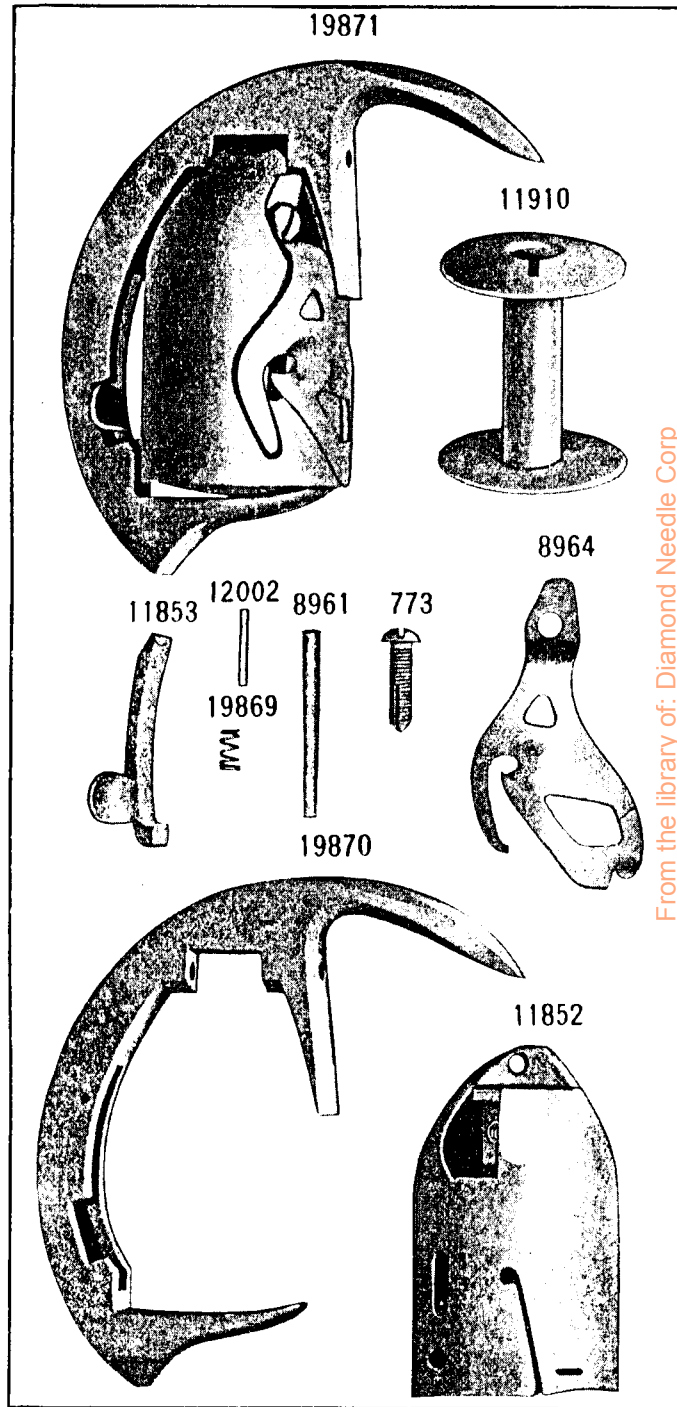


PLATE 3555—FULL SIZE



From the library of: Diamond Needle Corp

PLATE 6047—ONE-HALF SIZE

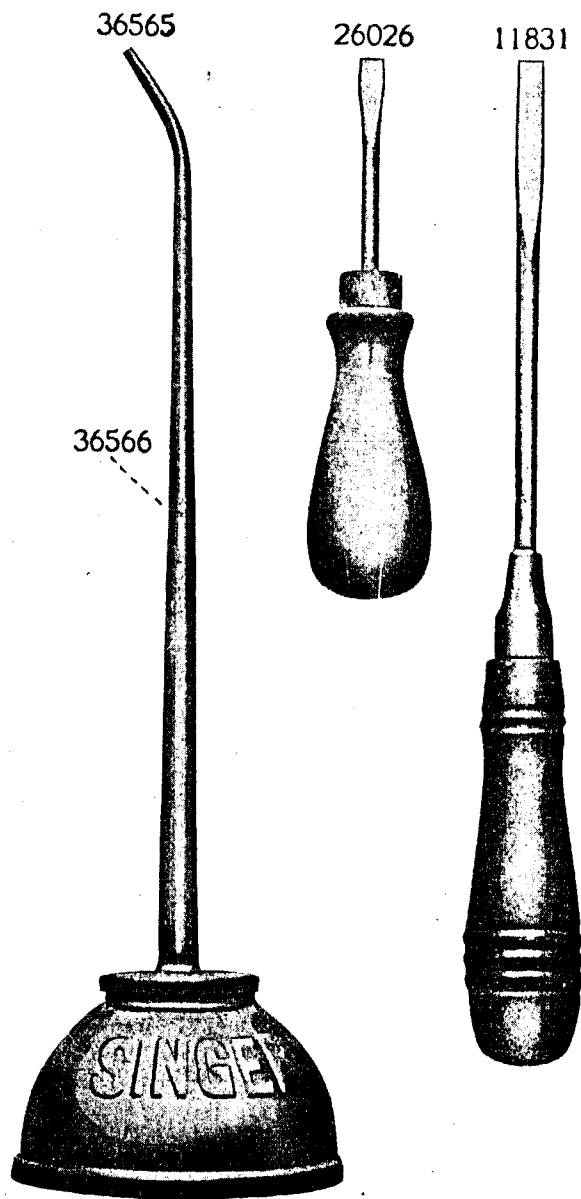
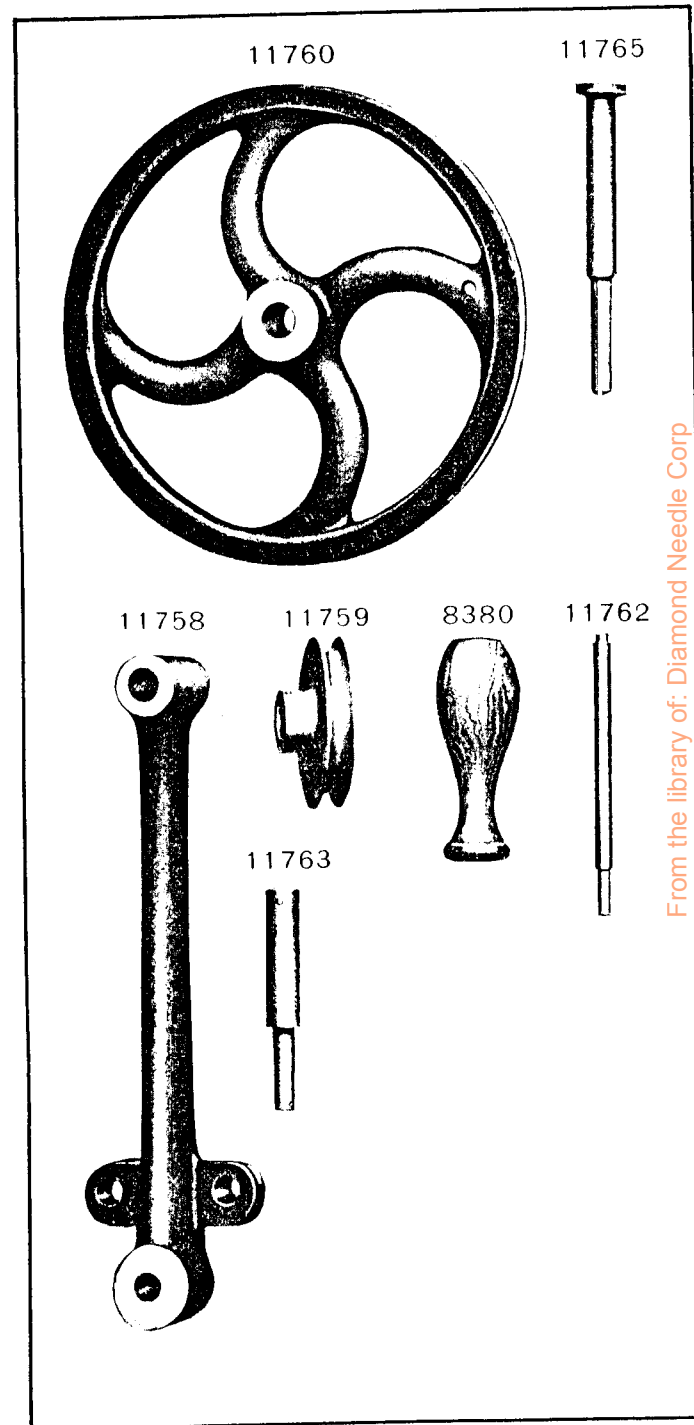


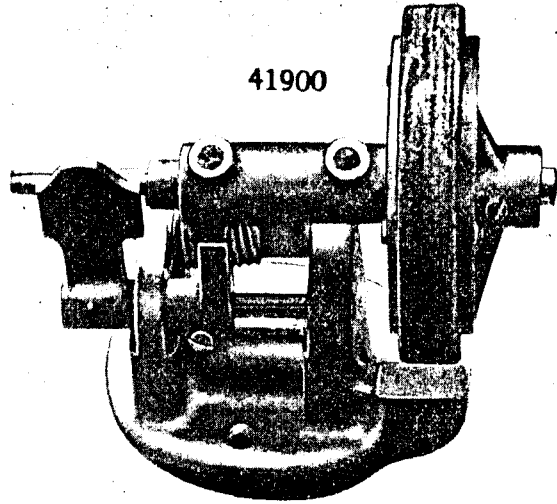
PLATE 6054—ONE-HALF SIZE



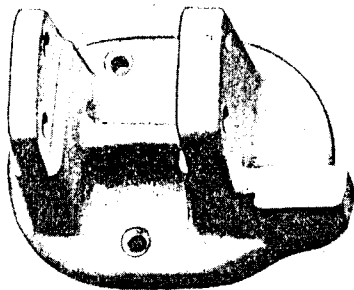
From the library of: Diamond Needle Corp

PLATE 6781—ONE-HALF SIZE

41900



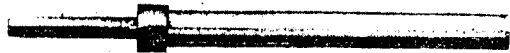
41894



41557



41898

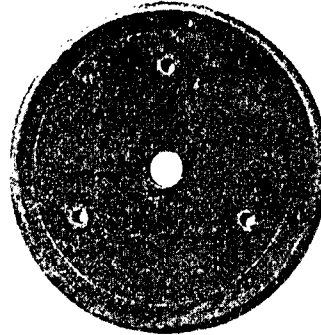


41446

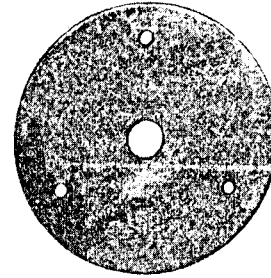


PLATE 6782—ONE-HALF SIZE

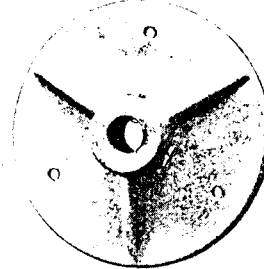
43176



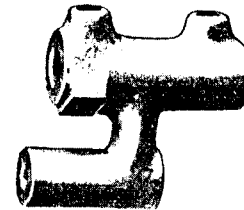
43178



43177



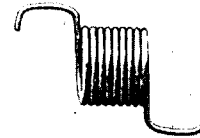
41896



41441



41897



41899



PLATE 6792—ONE-FOURTH SIZE

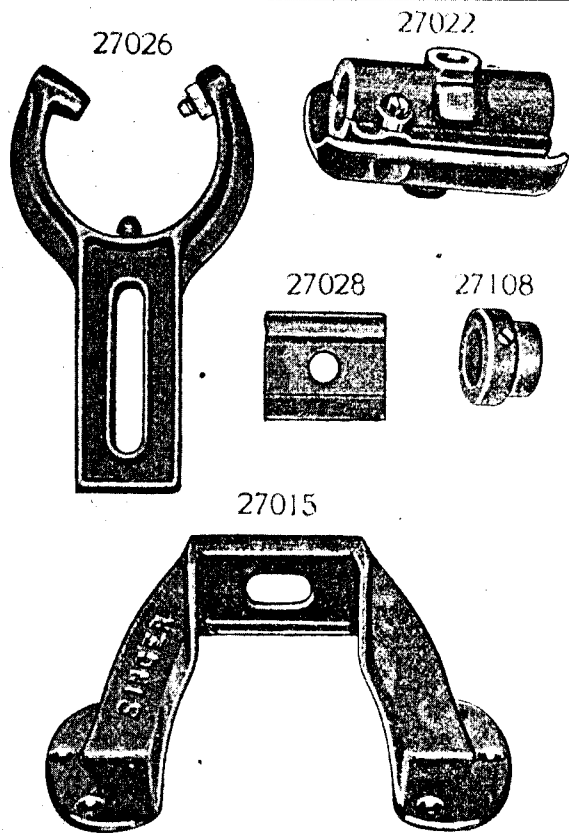
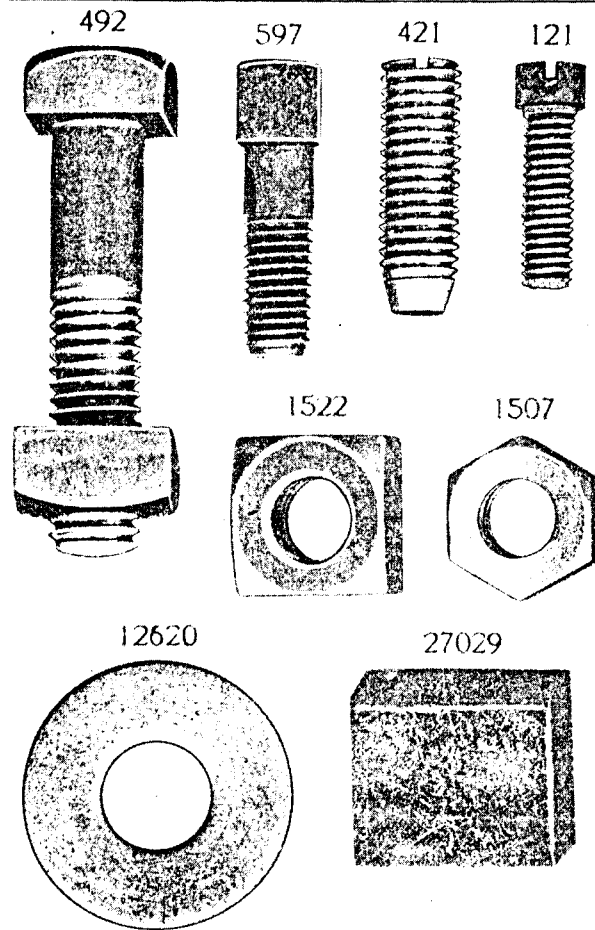


PLATE 6793—FULL SIZE



From the library of: Diamond Needle Corp

PLATE 7250—FULL SIZE

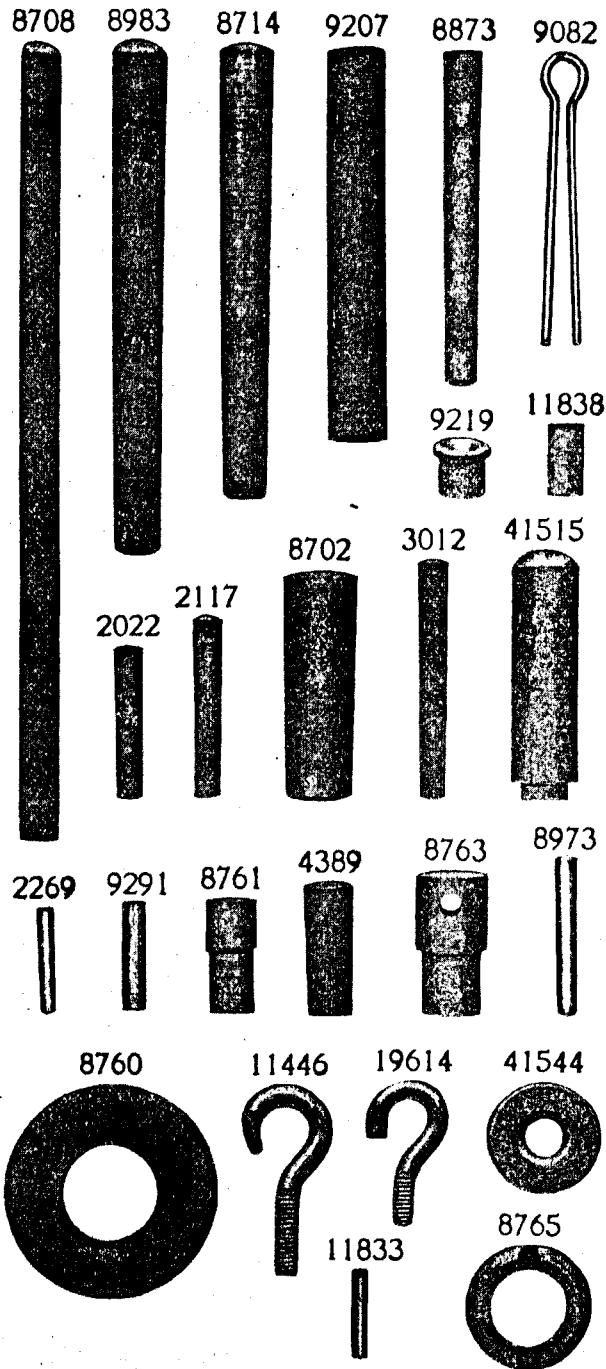


PLATE 7251—ONE-FOURTH SIZE

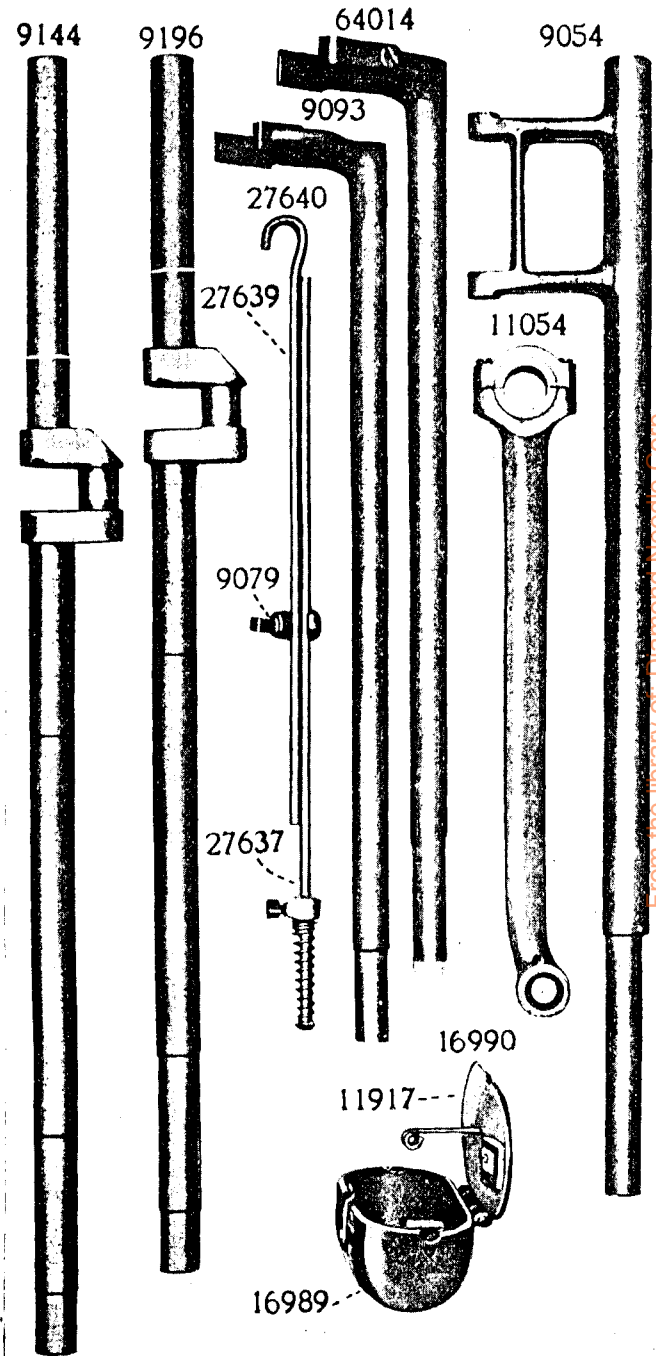


PLATE 7252—ONE-FOURTH SIZE

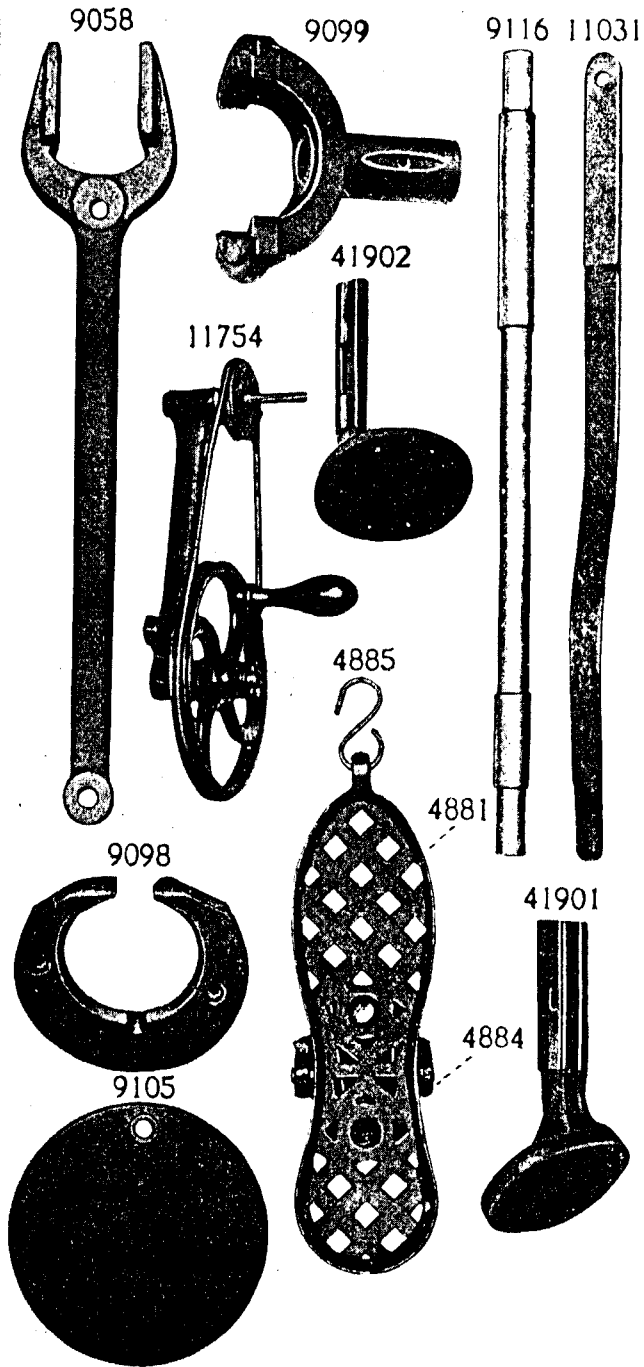
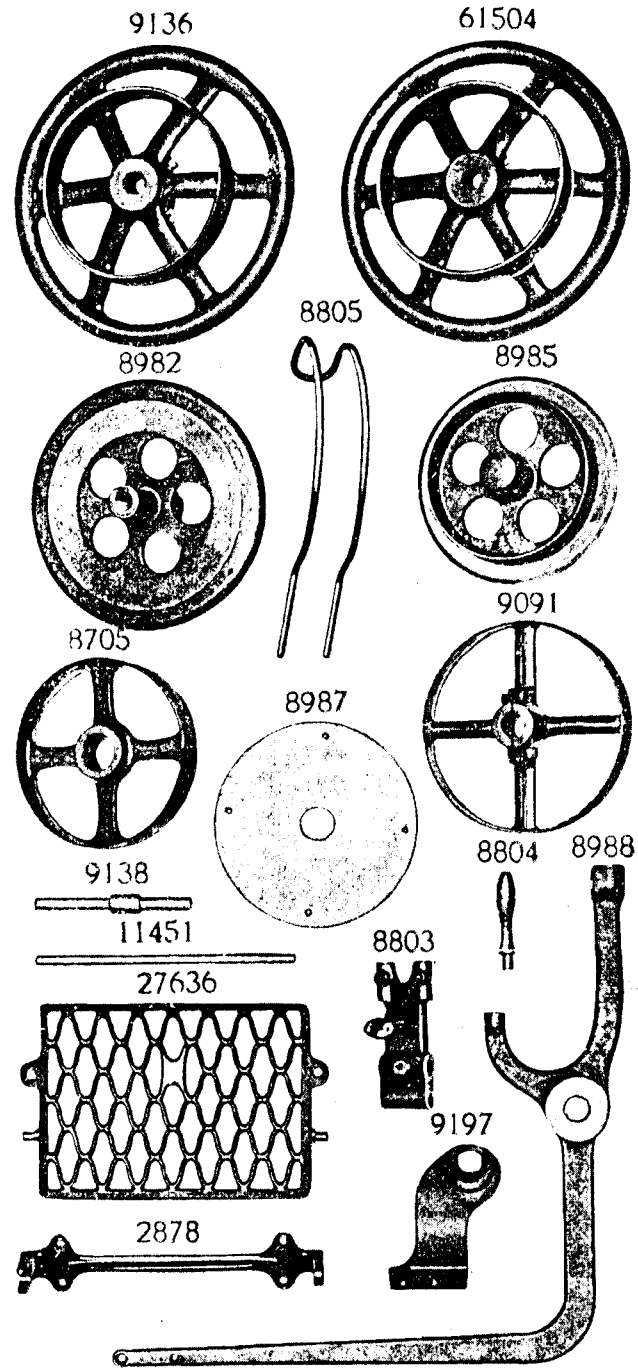


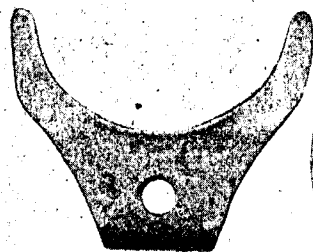
PLATE 7253—ONE-NINTH SIZE



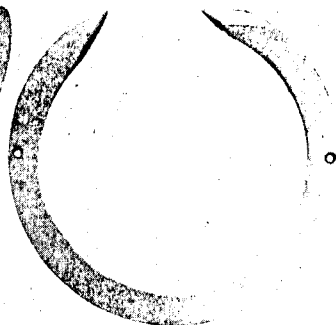
From the library of: Diamond Needle Corp

PLATE 7255—ONE-HALF SIZE

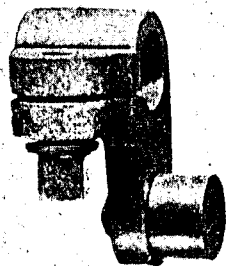
11834



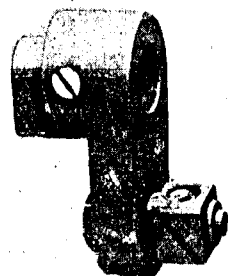
11832



64016



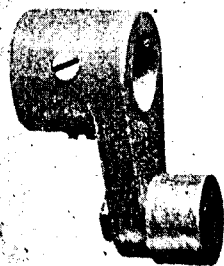
9154



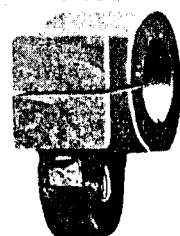
8927



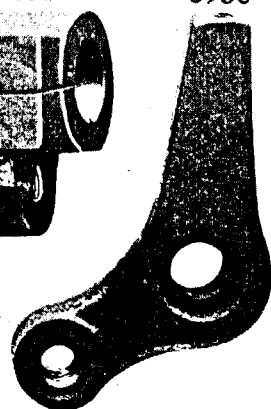
9096



9211



8930



8994

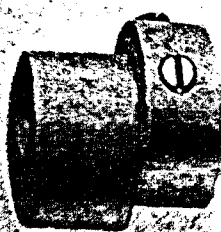
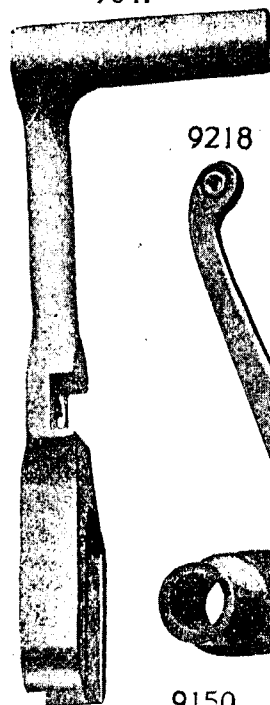


PLATE 7259—ONE-HALF SIZE

8745



9047



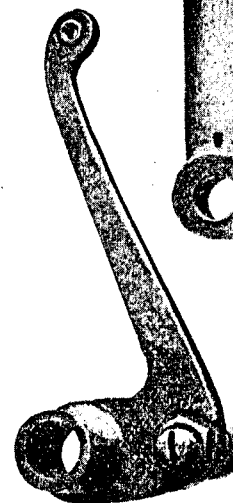
8746



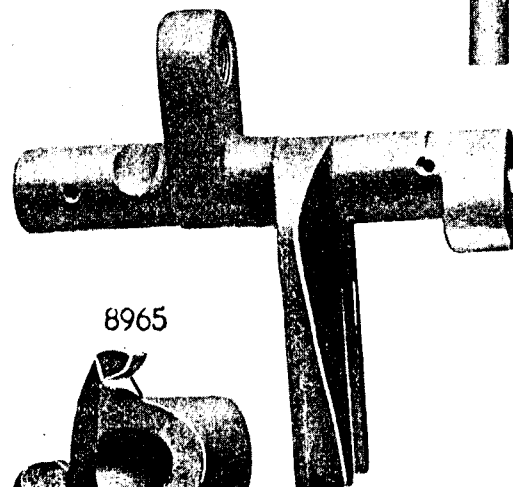
9115



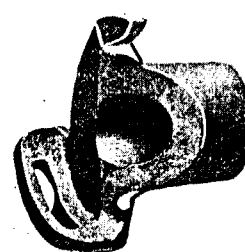
9218



9150



8965



From the library of: Diamond Needle Corp

PLATE 7260—FULL SIZE

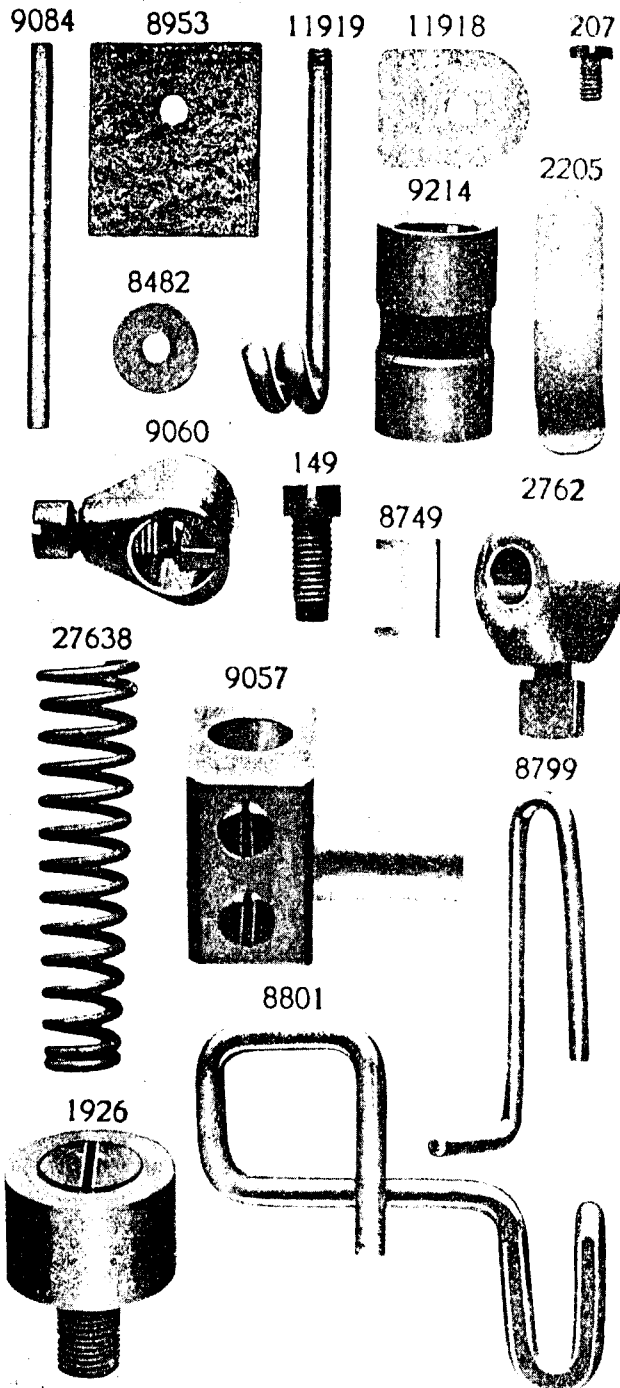
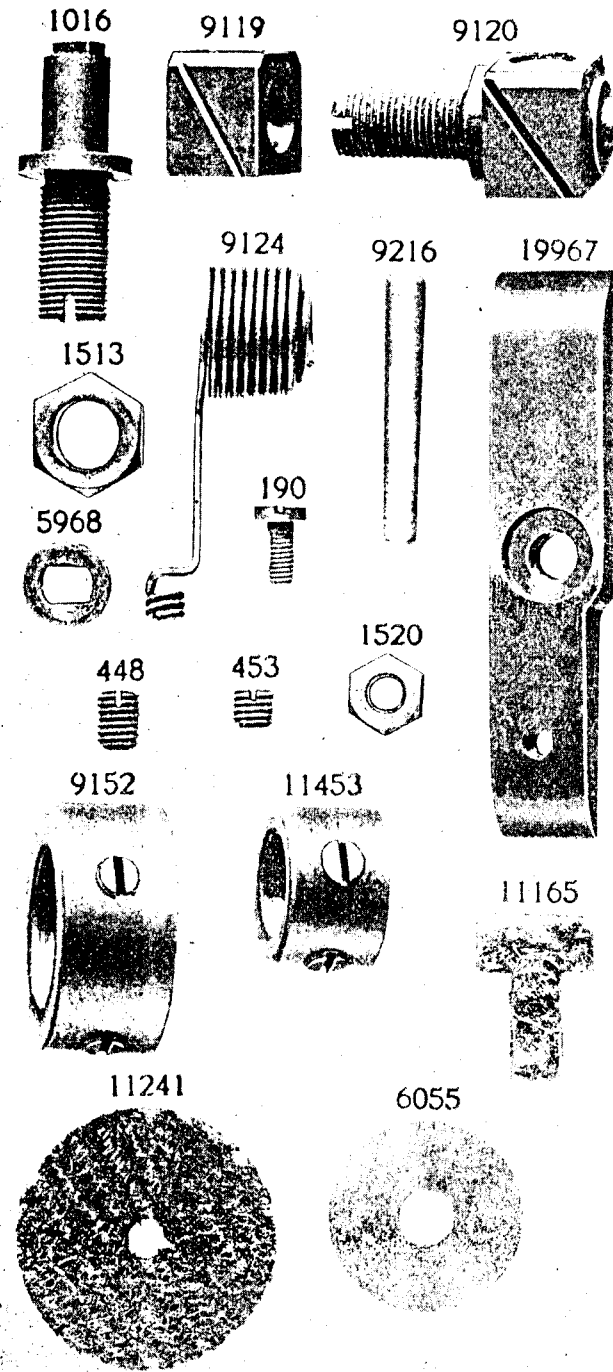


PLATE 7263—FULL SIZE



From the library of: Diamond Needle Corp

PLATE 7267—ONE-HALF SIZE

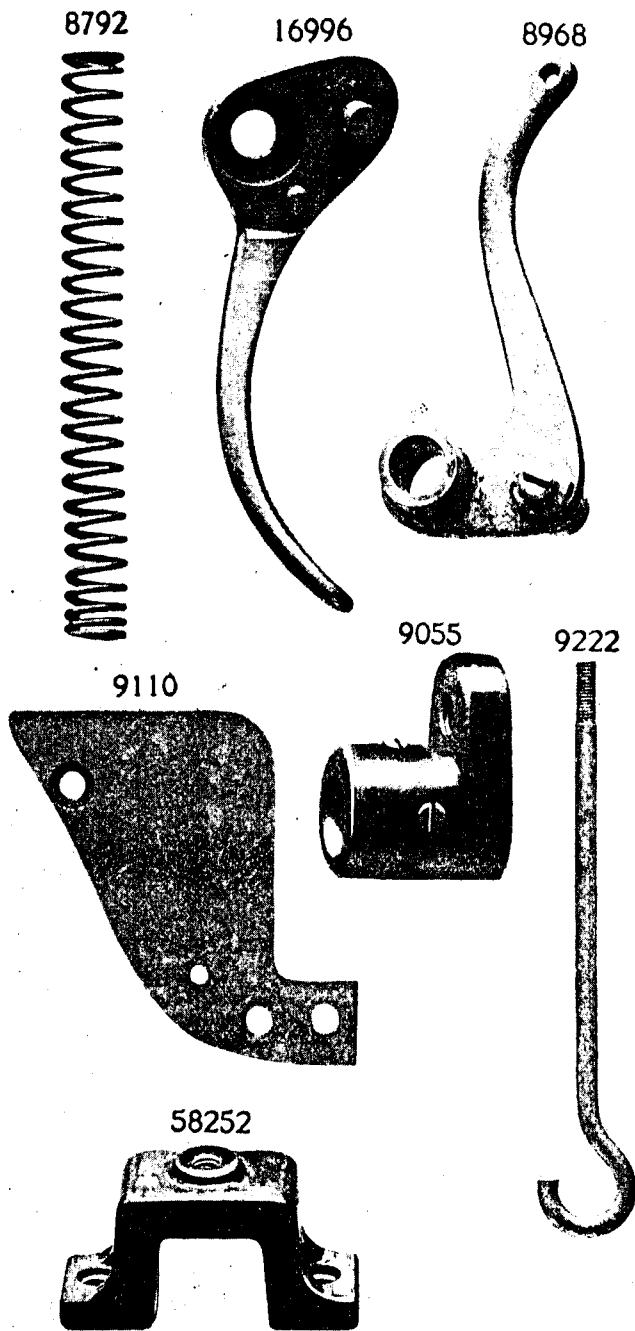
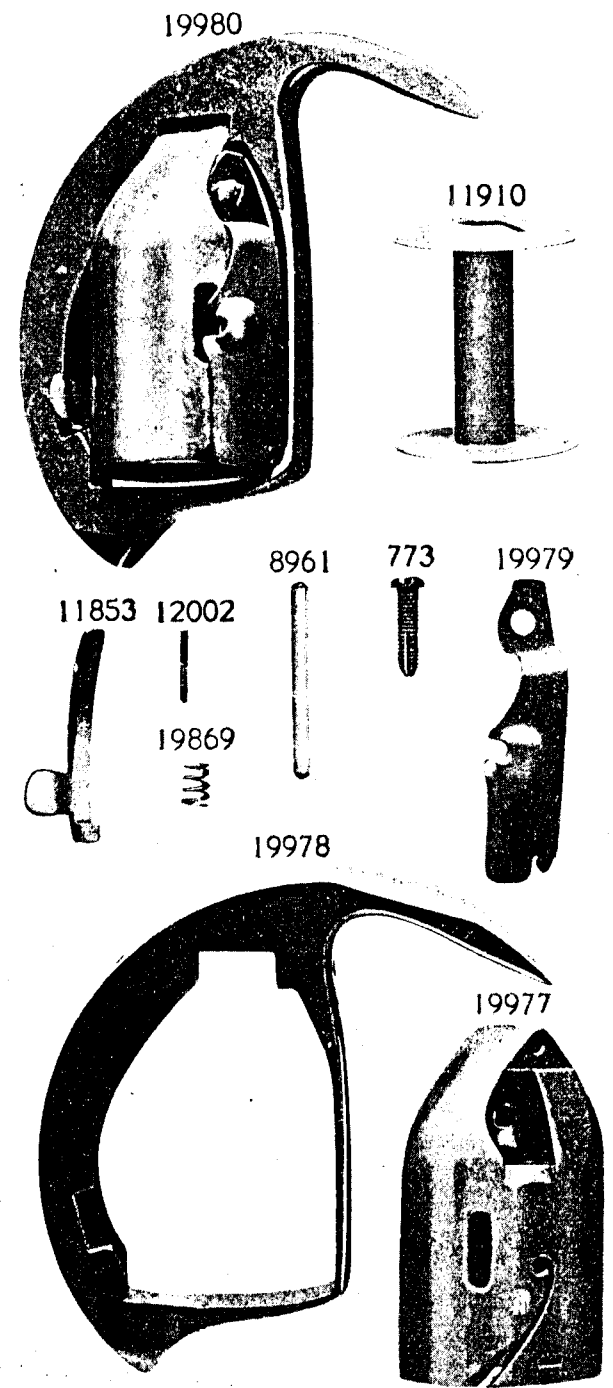


PLATE 7268—FULL SIZE



From the library of: Diamond Needle Corp

PLATE 7269—ONE-HALF SIZE

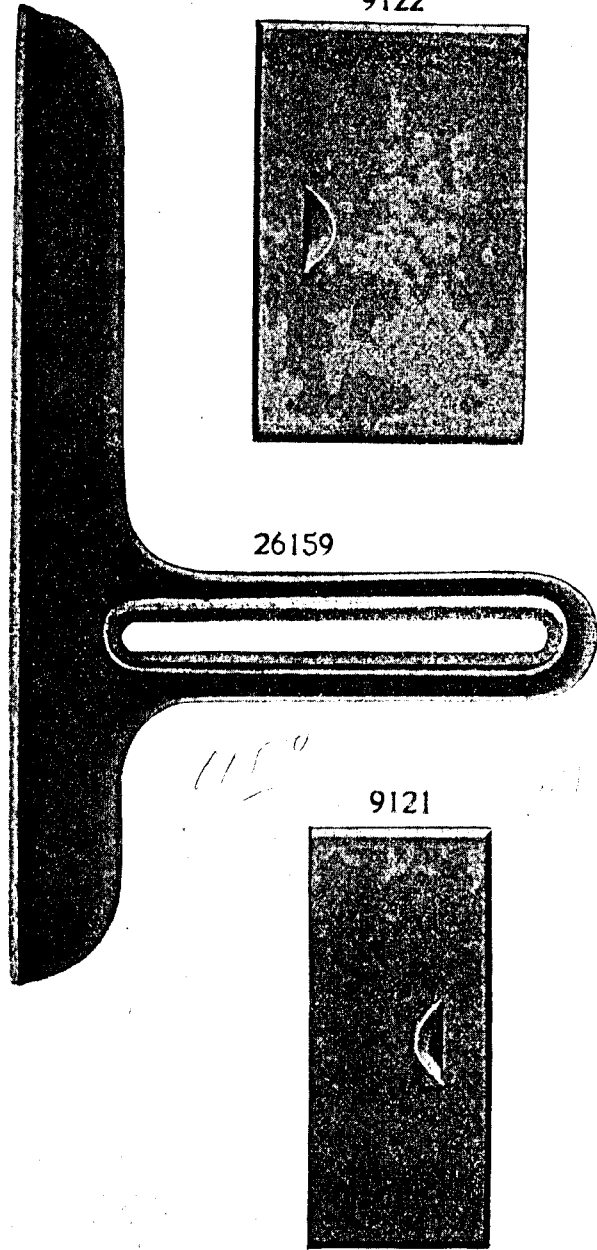
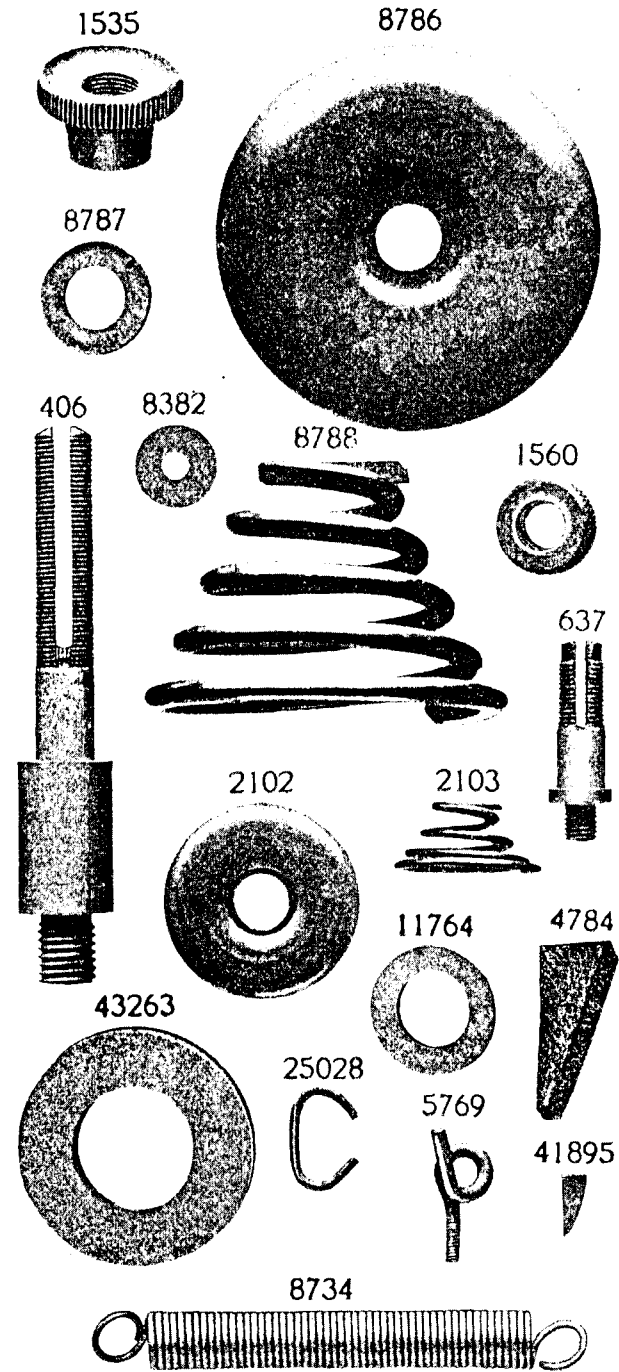


PLATE 7270—FULL SIZE



From the library of: Diamond Needle Corp

PLATE 7273—ONE-HALF SIZE

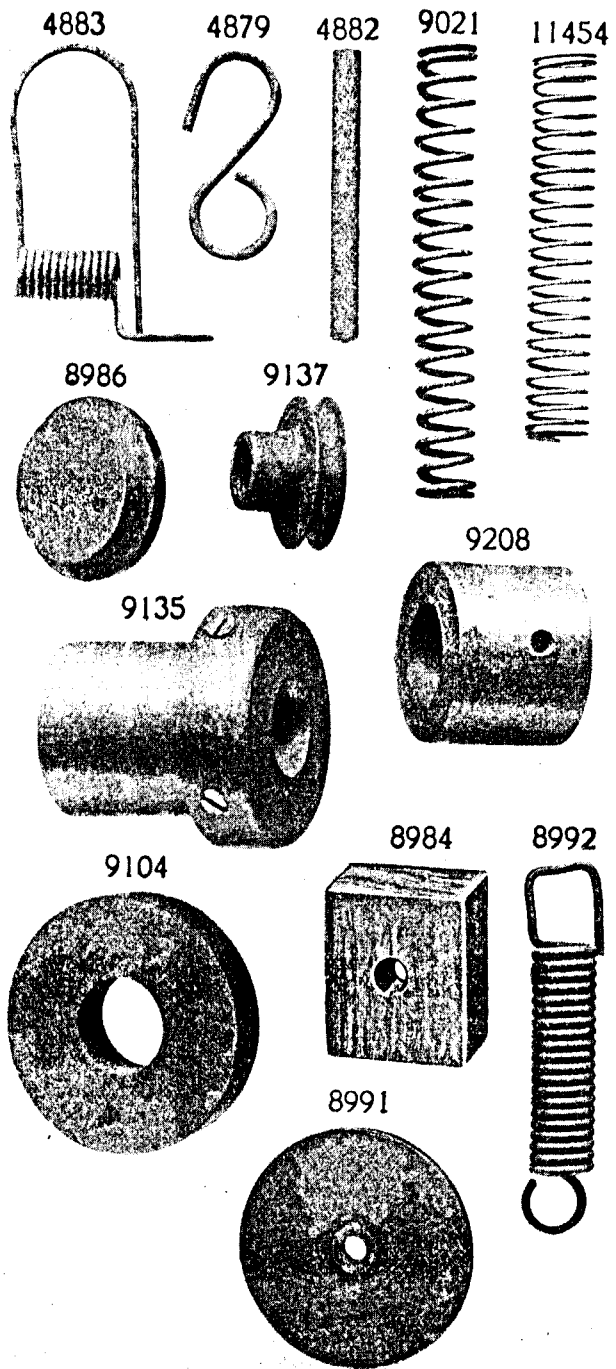


PLATE 7274—FULL SIZE

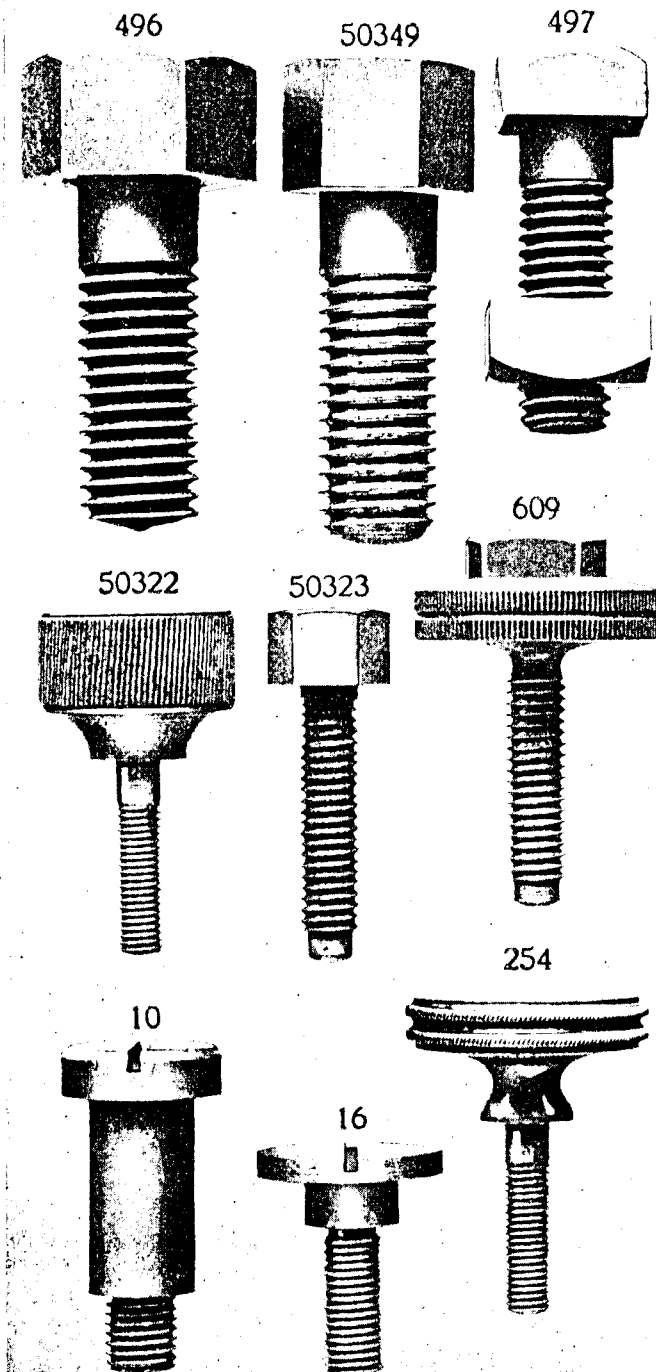


PLATE 7275—FULL SIZE

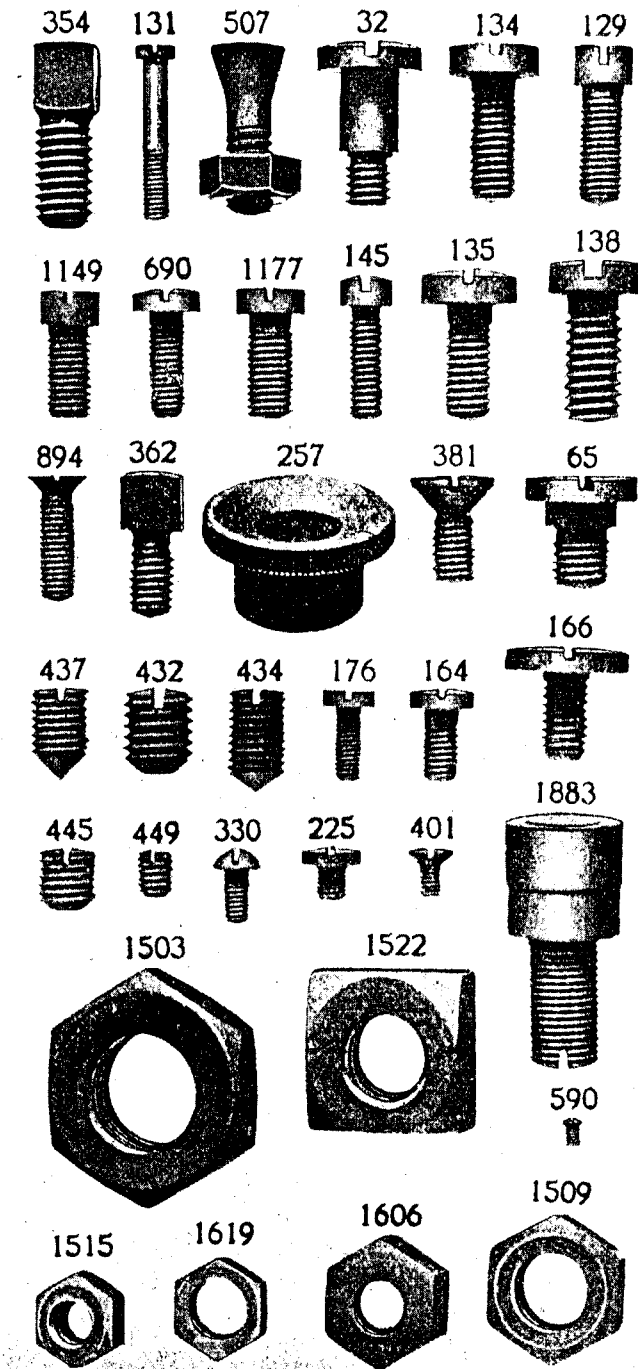
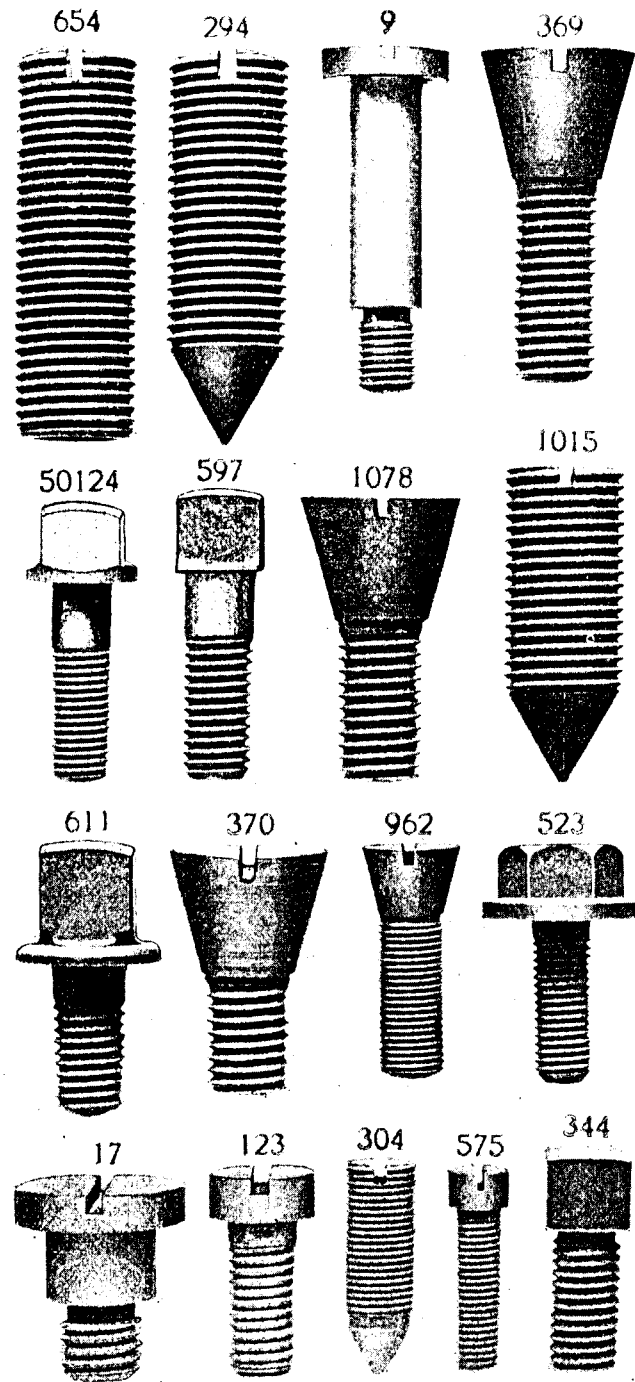


PLATE 7276—FULL SIZE



From the library of: Diamond Needle Corp

PLATE 7284—ONE-HALF SIZE

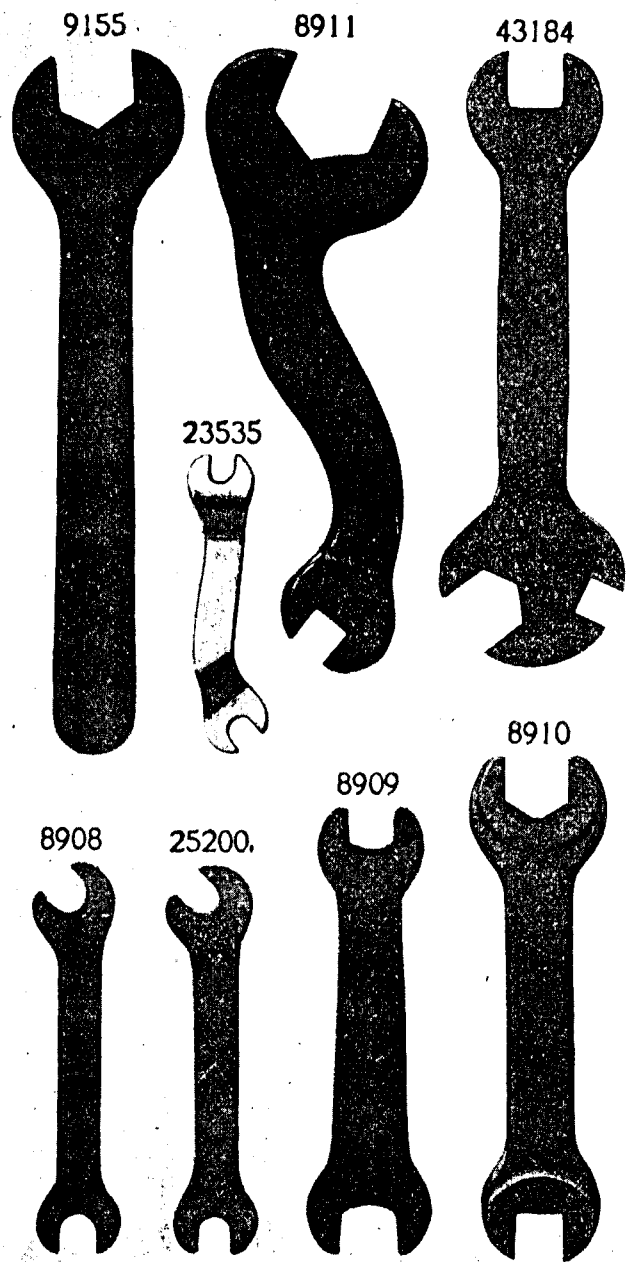
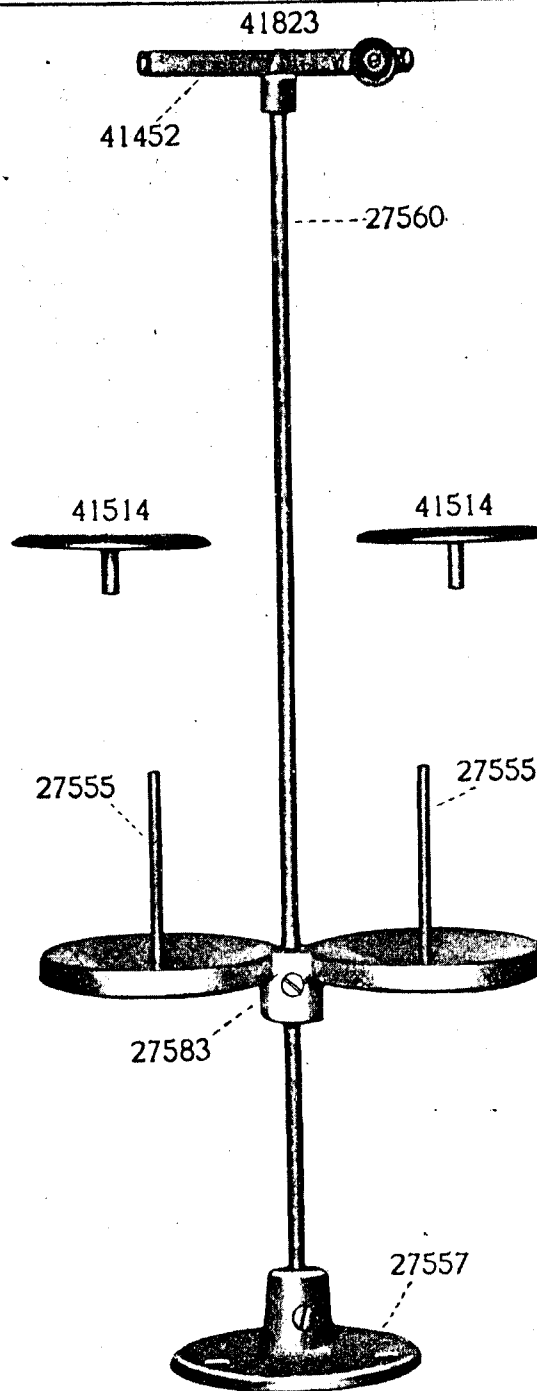


PLATE 7285—ONE-FOURTH SIZE



From the library of: Diamond Needle Corp

PLATE 7288—FULL SIZE

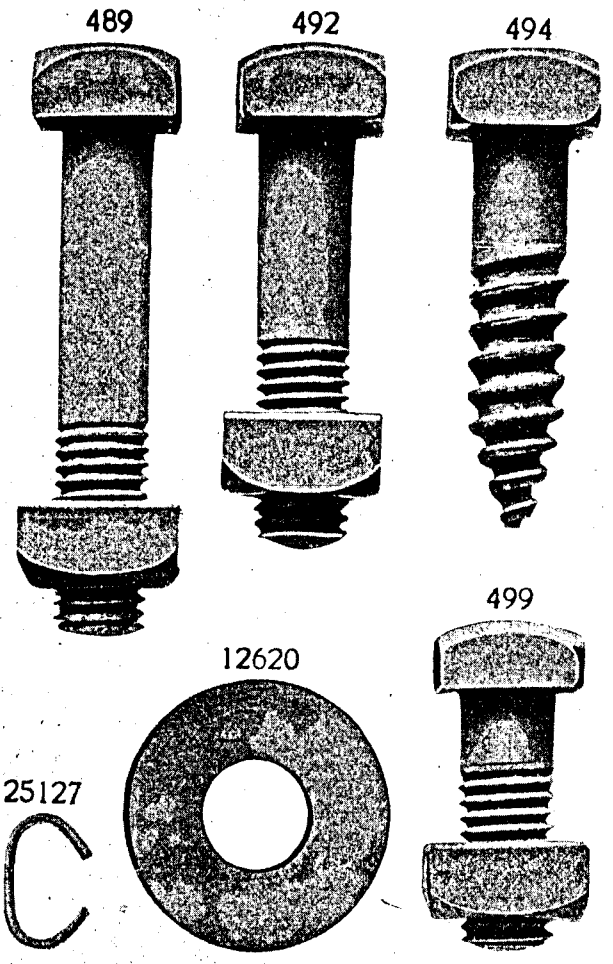
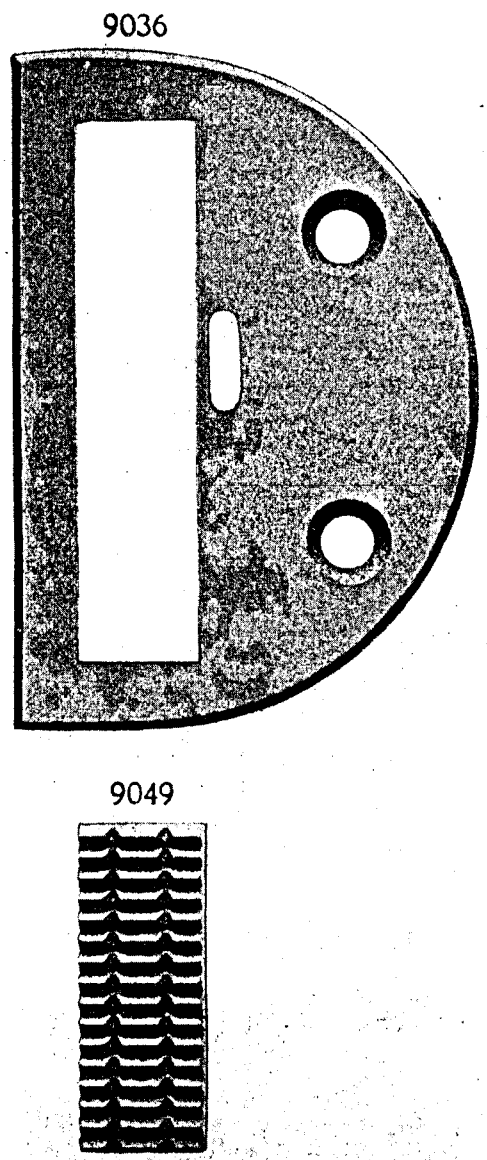


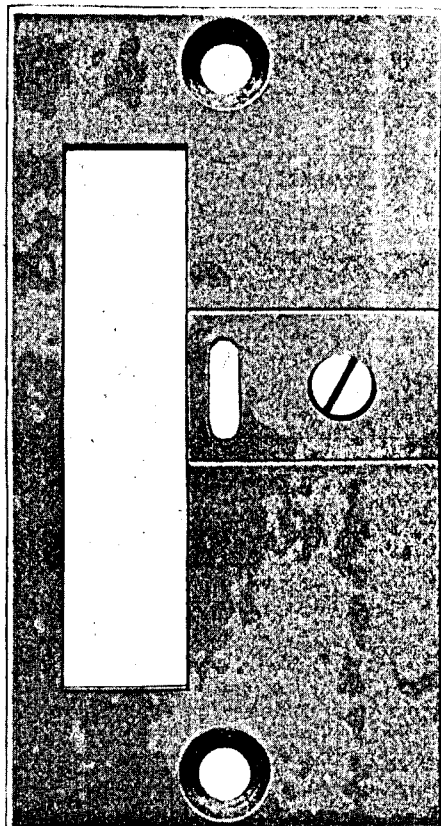
PLATE 7296—FULL SIZE



From the library of: Diamond Needle Corp

PLATE 7297—FULL SIZE

9125



9049



9126

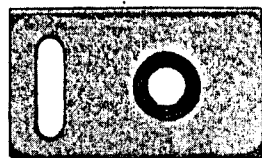


PLATE 7298—ONE-HALF SIZE

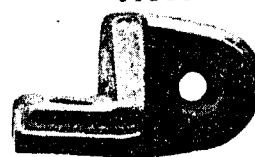
9145



11025

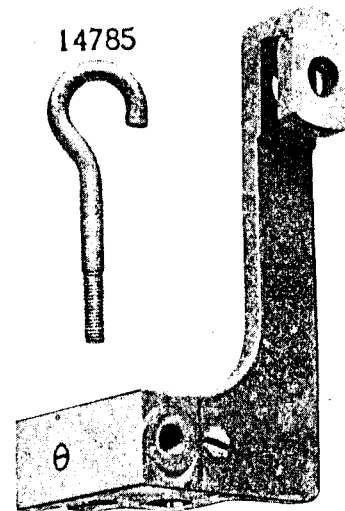


11361

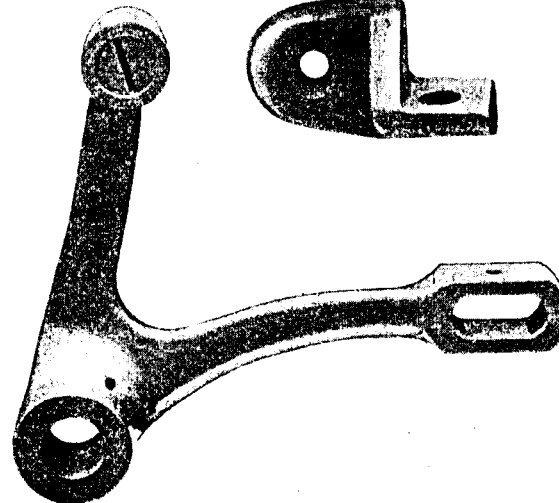


11071

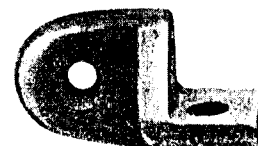
14785



9107



11360



From the library of: Diamond Needle Corp

PLATE 7299—ONE-HALF SIZE

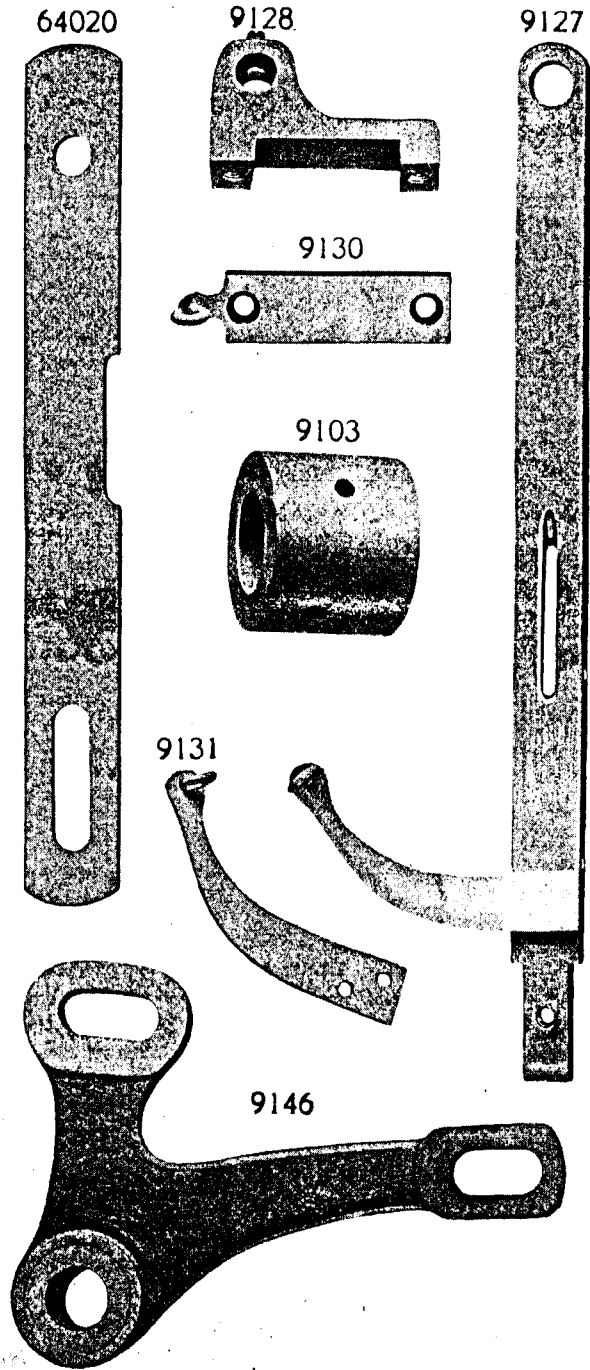
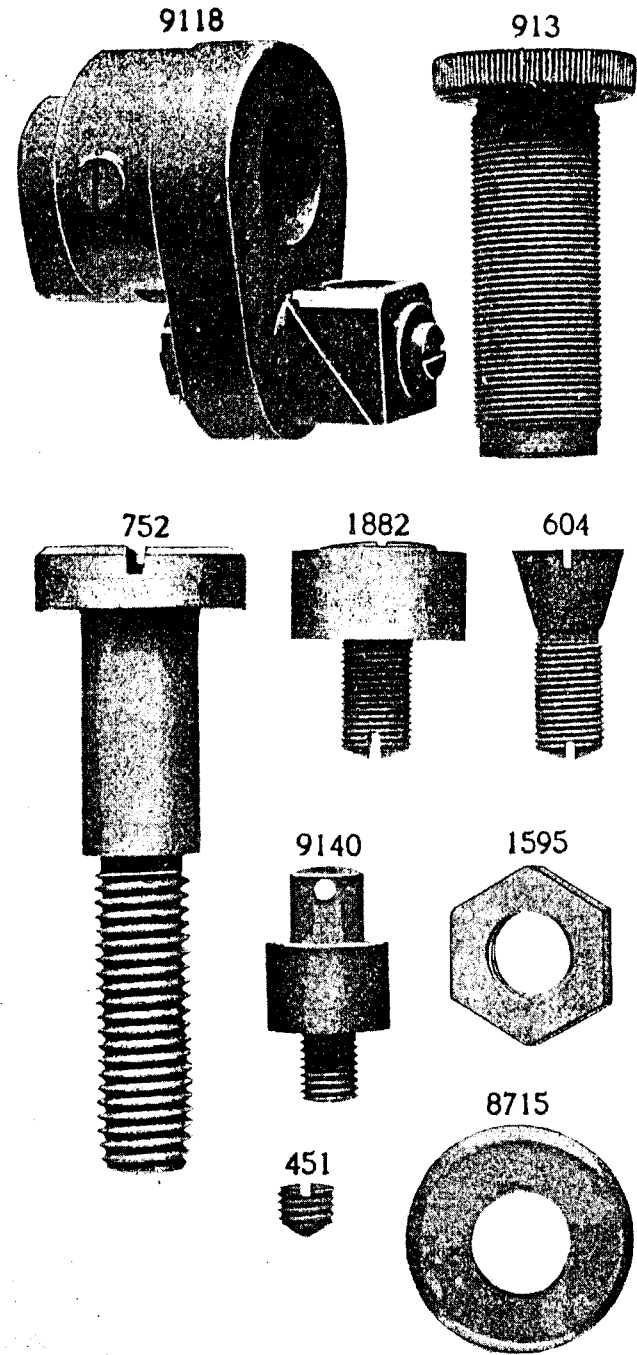


PLATE 7300—FULL SIZE



From the library of: Diamond Needle Corp

PLATE 7301—FULL SIZE

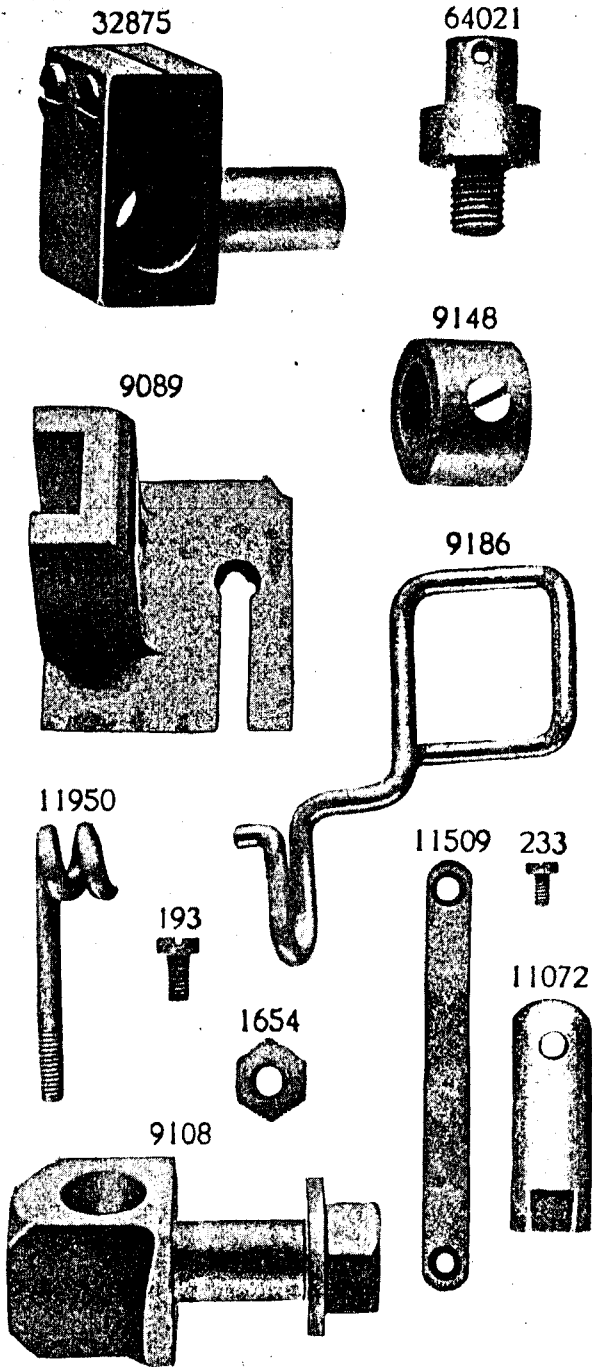


PLATE 7302—ONE-FOURTH SIZE

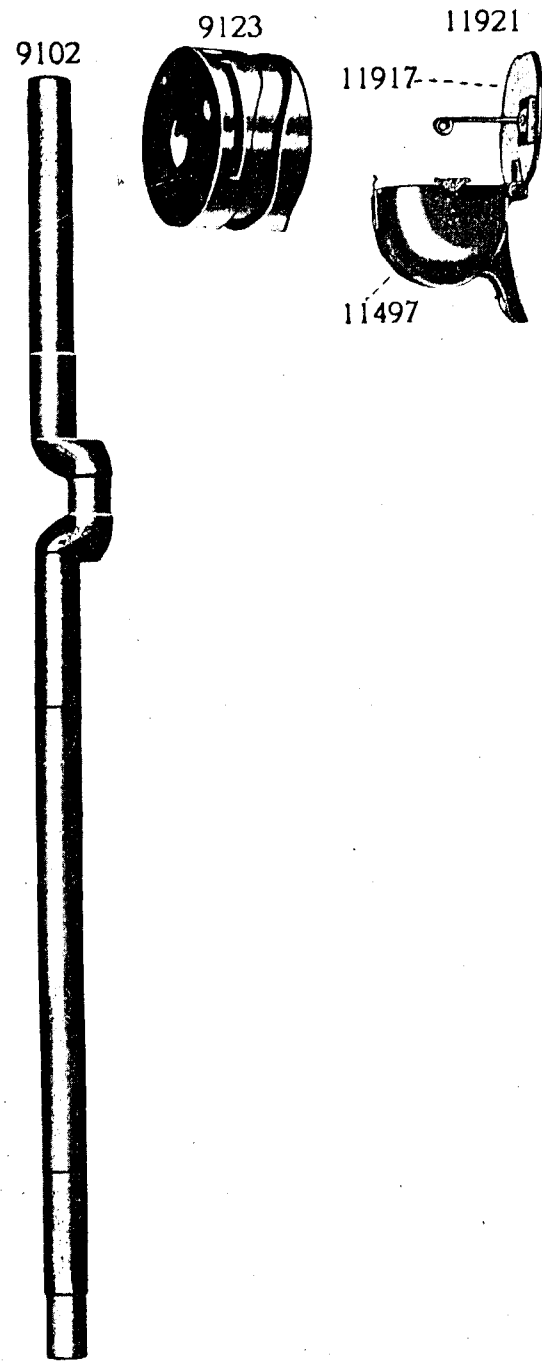


PLATE 7303—ONE-NINTH SIZE

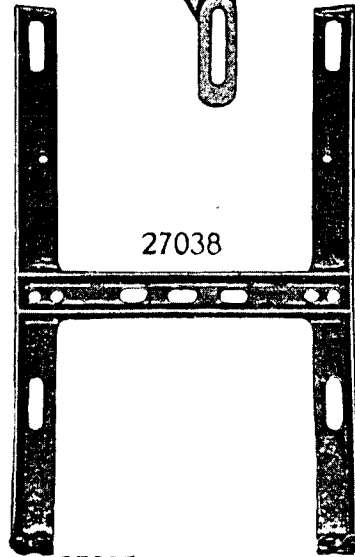
27006



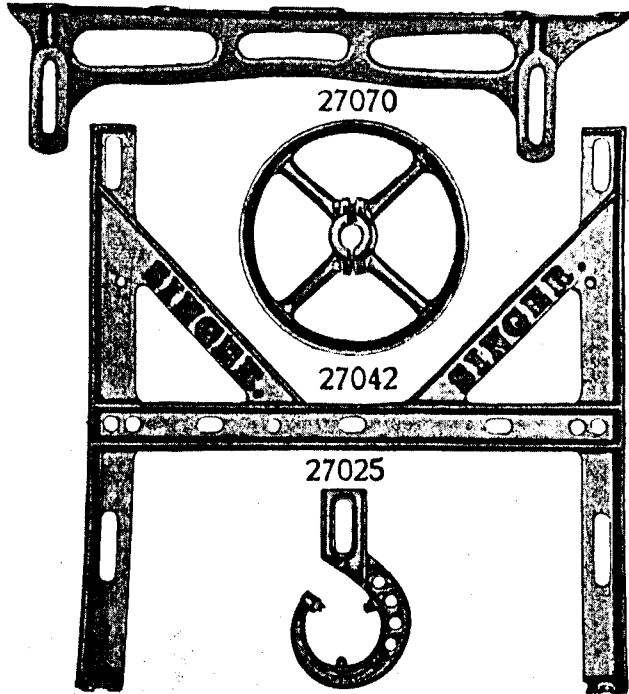
27139



27038



27095



27070

27042

27025

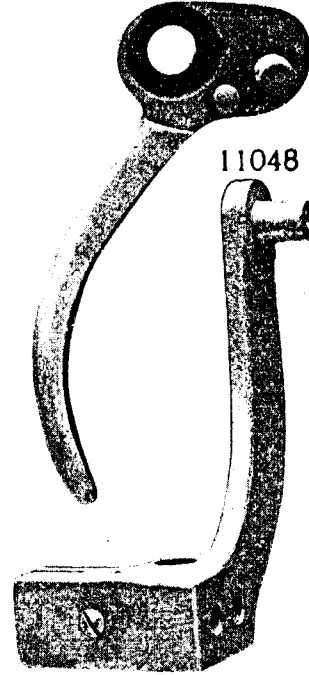


PLATE 7304—ONE-HALF SIZE

9149



16960

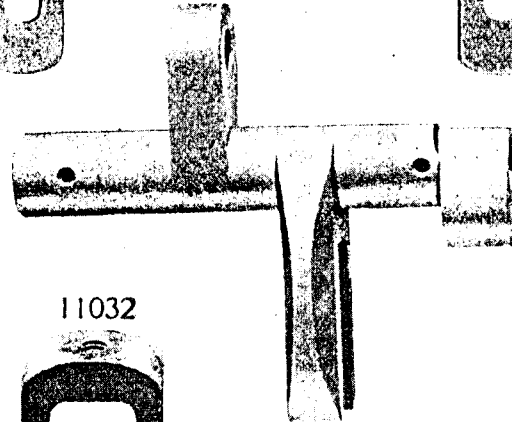


11048

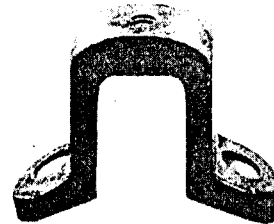
9111



9113



11032



From the library of: Diamond Needle Corp